

► Kontron User's Guide

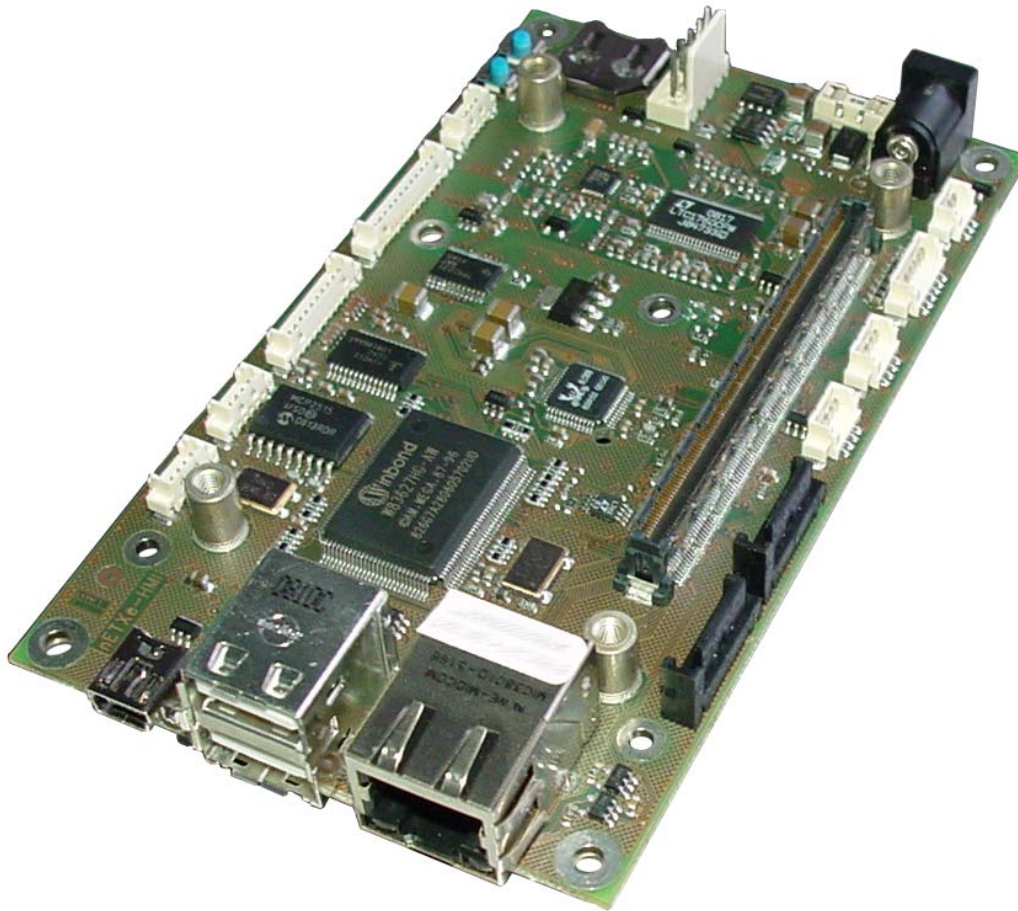

► nanoETXexpress-HMI Baseboard (ePDAnano)

Document Revision 1.11

This page intentionally left blank

Table of Contents

1	User Information.....	6
1.1	About This Document	6
1.2	Copyright Notice	6
1.3	Trademarks	6
1.4	Standards	6
1.5	Warranty	6
1.6	Technical Support.....	7
2	Short description.....	9
2.1	Features:	9
2.2	General overview:.....	10
3	Specifications	11
3.1	Mechanical specifications	11
3.2	Electical Specification	12
3.2.1	Supply Voltage.....	12
3.2.2	Supply Voltage Ripple	12
3.2.3	Supply Current.....	12
3.3	Environmental specifications.....	12
3.3.1	Temperature.....	12
3.3.2	Humidity	12
3.4	Mounting instructions.....	13
4	Mechanical and functional layout	13
4.1	Block diagram	13
4.2	Connector layout and part placement.....	14
4.2.1	Top view	14
4.2.2	Bottom view.....	15
5	Connector and feature description	16
5.1	COM Express™ connector (X1).....	16
5.2	USB.....	16
5.2.1	USB Host 0/1 (X2)	16
5.2.2	USB Host 2 (X20)	17
5.2.3	USB Host 3 (X19)	17
5.2.4	USB Client (X10)	17
5.3	Ethernet (X3)	18
5.4	SATA Ports	19
5.4.1	SATA0 (X4).....	19

5.4.2	SATA1 (X5).....	19
5.5	Express Card Socket (X7).....	20
5.6	JILI (X9).....	21
5.7	VGA Port (X8)	22
5.8	Serial Ports	23
5.8.1	COM1 RS232 (X12).....	23
5.8.2	COM2 RS485 (X13).....	23
5.9	CAN (X14)	24
5.10	microSD Socket (X15).....	24
5.11	FAN (X16)	25
5.12	GPIO (X18).....	25
5.13	Power (X6).....	26
5.14	External Buttons (X21).....	26
5.15	SmartBattery (X23)	26
5.16	Audio (X24)	27
6	Battery Information (BAT1).....	28
7	Security advice.....	29
8	Smart Battery system and dual buck converter.....	30
8.1	Introduction	30
8.2	Possible Smart Batteries	30
8.3	Smart Battery System Manager	30
8.4	Dual Buck Converter.....	31
9	HD-Audio-Connector-Board (B08700-KAB-XXX-XX01).....	32
9.1	Mechanical Specifications:	32
9.2	Connector Description:.....	32
10	CAN controller	33
10.1	Introduction	33
10.2	Further information	33
11	Optional features	34
11.1	ATX mode / AT mode	34
11.2	Optional Power Connector	34
11.3	Disclaimer for customer modifications	34
12	Recommended Cables.....	35
12.1	KAB-CAN-1; 96065-0000-00-0	35
12.2	KAB-DSUB-3; 96061-0000-00-0	35
12.3	KAB-VGA-2; 96053-0000-00-0	36

12.4 KAB-USB-1; 96054-0000-00-0..... 36

13 Document History.....37

1 User Information

1.1 About This Document

This document provides information about products from Kontron Embedded Modules GmbH and/or its subsidiaries. No warranty of suitability, purpose, or fitness is implied. While every attempt has been made to ensure that the information in this document is accurate, the information contained within is supplied "as-is" and is subject to change without notice.

For the circuits, descriptions and tables indicated, Kontron assumes no responsibility as far as patents or other rights of third parties are concerned.

1.2 Copyright Notice

Copyright © 2003-2007 Kontron Embedded Modules GmbH

All rights reserved. No part of this document may be reproduced, transmitted, transcribed, stored in a retrieval system, or translated into any language or computer language, in any form or by any means (electronic, mechanical, photocopying, recording, or otherwise), without the express written permission of Kontron Embedded Modules GmbH.

DIMM-PC®, PISA®, ETX®, ETXexpress®, microETXexpress™, X-board®, DIMM-IO® and DIMM-BUS® are trademarks or registered trademarks of Kontron Embedded Modules GmbH. Kontron is trademark or registered trademark of Kontron AG.

1.3 Trademarks

The following lists the trademarks of components used in this board.

- IBM, XT, AT, PS/2 and Personal System/2 are trademarks of International Business Machines Corp.
- Microsoft is a registered trademark of Microsoft Corp.
- Intel is a registered trademark of Intel Corp.
- All other products and trademarks mentioned in this manual are trademarks of their respective owners.

1.4 Standards

Kontron Embedded Modules GmbH is certified to ISO 9000 standards.

1.5 Warranty

This Kontron Embedded Modules GmbH product is warranted against defects in material and workmanship for the warranty period from the date of shipment. During the warranty period, Kontron Embedded Modules GmbH will at its discretion decide to repair or replace defective products.

Within the warranty period, the repair of products is free of charge as long as warranty conditions are observed.

The warranty does not apply to defects resulting from improper or inadequate maintenance or handling by the buyer, unauthorized modification or misuse, operation outside of the product's environmental specifications or improper installation or maintenance.

Kontron Embedded Modules GmbH will not be responsible for any defects or damages to other products not supplied by Kontron Embedded Modules GmbH that are caused by a faulty Kontron Embedded Modules GmbH product.

1.6 Technical Support

Technicians and engineers from Kontron Embedded Modules GmbH and/or its subsidiaries are available for technical support. We are committed to making our product easy to use and will help you use our products in your systems.

Please consult our Web site at <http://www.kontron.com/support> for the latest product documentation, utilities, drivers and support contacts. In any case you can always contact your board supplier for technical support.

2 Short description

The ePDAnano is a COM Express™ pin-out type 1 compatible baseboard and is compliant with the new nanoETXexpress standard.

2.1 Features:

- 2x SATA
- 4x USB 2.0/1.1
- 1x USB 2.0 client
- ExpressCard 34/54 slot
- 10/100/1000 Mbit Ethernet
- HD Audio Codec Realtek ALC888
- (Audio board as additional part)
- Flat Panel Interface JILI
- VGA (CRT)
- 2x COM (1x RS232, 1x RS485)
- CAN controller MCP2515
- microSD memory card slot
- 8 bit GPIO
- Smart Battery system (SM bus)
- Single voltage power supply

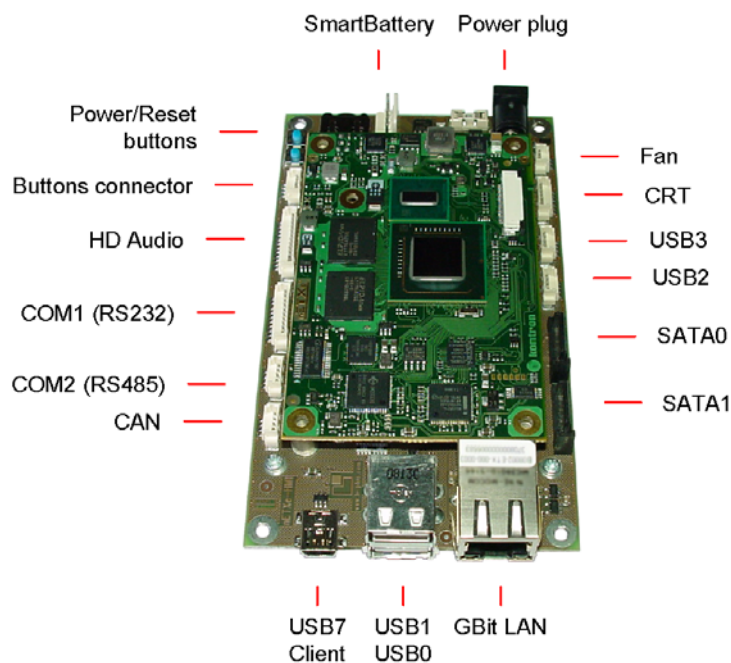

2.2 General overview:

This ready to use open frame solution is a flexible design platform for various embedded computing applications in miscellaneous areas, for example in POS/POI terminals or industrial automation. It drives TFT & CRT displays in different sizes and resolutions. The dedicated baseboard is offering I/O functionality by carrying a standard x86 CPU module with integrated graphics utilizing Windows® operating systems (for example XP/XPe/CE/...) or Linux. Key features are an ideal Performance/Watt ratio due to i.e. the newest low power 45nm Atom™ CPUs from Intel® as well as numerous I/O options which are implemented via onboard plugs or supported by cabled connectors. Further I/O functionality, i.e. WLAN/WiFi, etc. can be optionally added. The kit in its compact dimensions can be mounted with a display frame or easily integrated in a standard or custom housing.

3 Specifications

3.1 Mechanical specifications

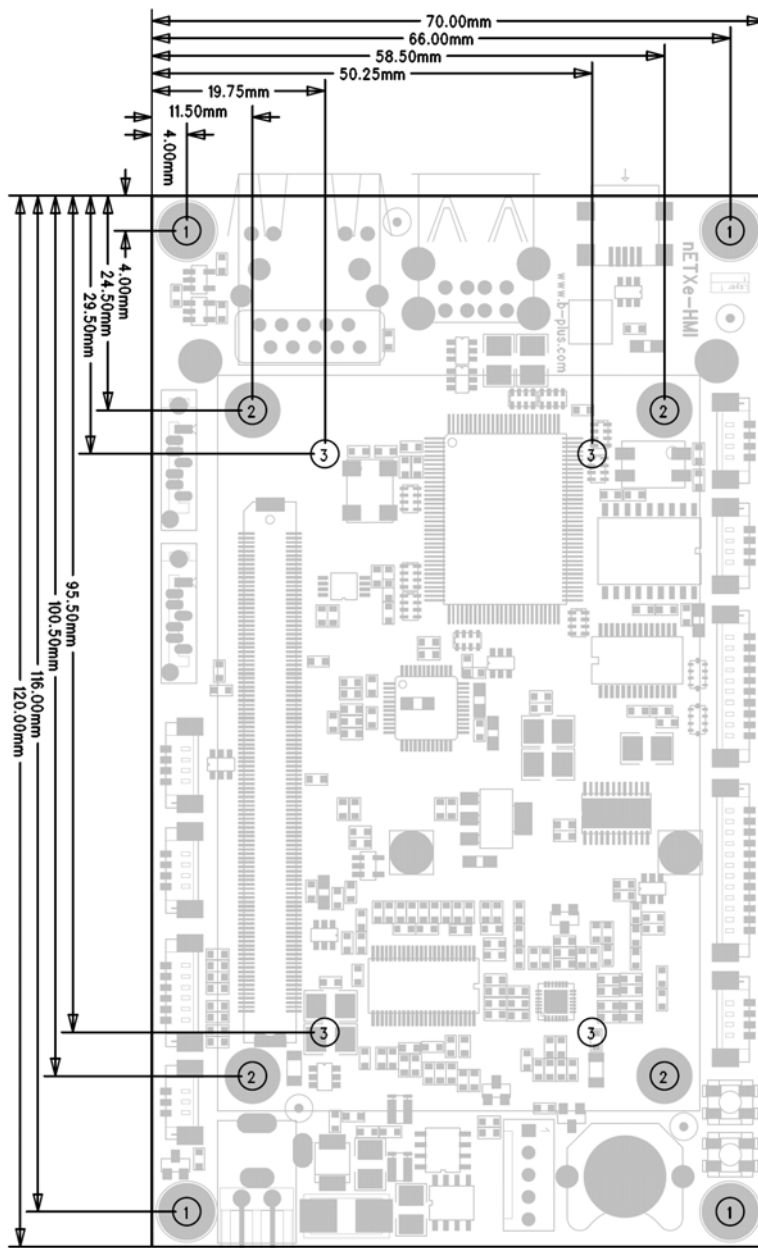

Mounting holes

①	Baseboard Mounting Hole diameter 3,2 mm
②	Module / Heatspreader Mounting Hole Threaded M3
③	Heatsink Mounting Hole Threaded M3

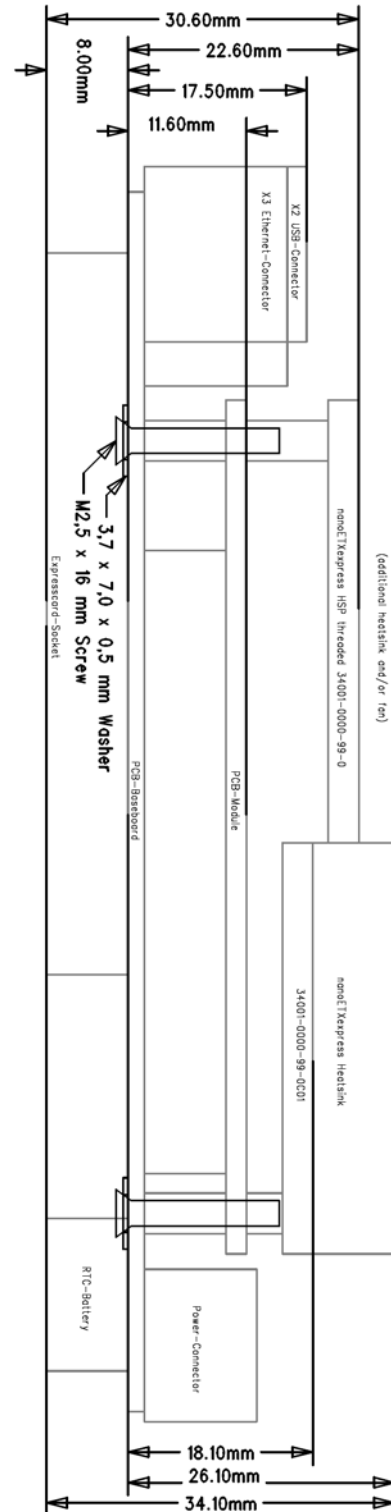

3.2 Electrical Specification

3.2.1 Supply Voltage

- 9.6 V to 14 V DC (nominal 12 V)
- lower end restricted through battery charger
- upper end restricted through COM Express™ pin-out type 1 module Specifications

3.2.2 Supply Voltage Ripple

- 100 mV peak to peak

3.2.3 Supply Current

The supply current depends on the used COM Express™ pin-out type 1 module and the connected peripherals.

A typical supply current with a Kontron nanoETXexpress-SP and connected peripherals (PM070WL4 display and backlight, USB Hub, USB Mouse, USB, Keyboard) and running Windows XP SP3 is about 1.35 A @ 12.0 V (approximately 16 W).

3.3 Environmental specifications

3.3.1 Temperature

Operating:

- Ambient temperature: 0 to +60 °C

Storage:

- Ambient temperature: -30 to +85 °C

Note: The maximum operating temperature is the maximum measurable temperature on any spot on a baseboards' surface. You must maintain the temperature according to the above specification.

3.3.2 Humidity

- Operating: 10% to 90% (non condensing)
- Non operating: 5% to 95% (non condensing)

3.4 Mounting instructions

- Click in the ExpressCard Socket
- Fix it with two M2 x 5 mm Screws
- Plug in the nanoETXexpress module
- Add the nanoETXexpress Heatsink
- Fix it with four 3,7 mm Washers and M2,5 x 16 mm Screws

4 Mechanical and functional layout

4.1 Block diagram

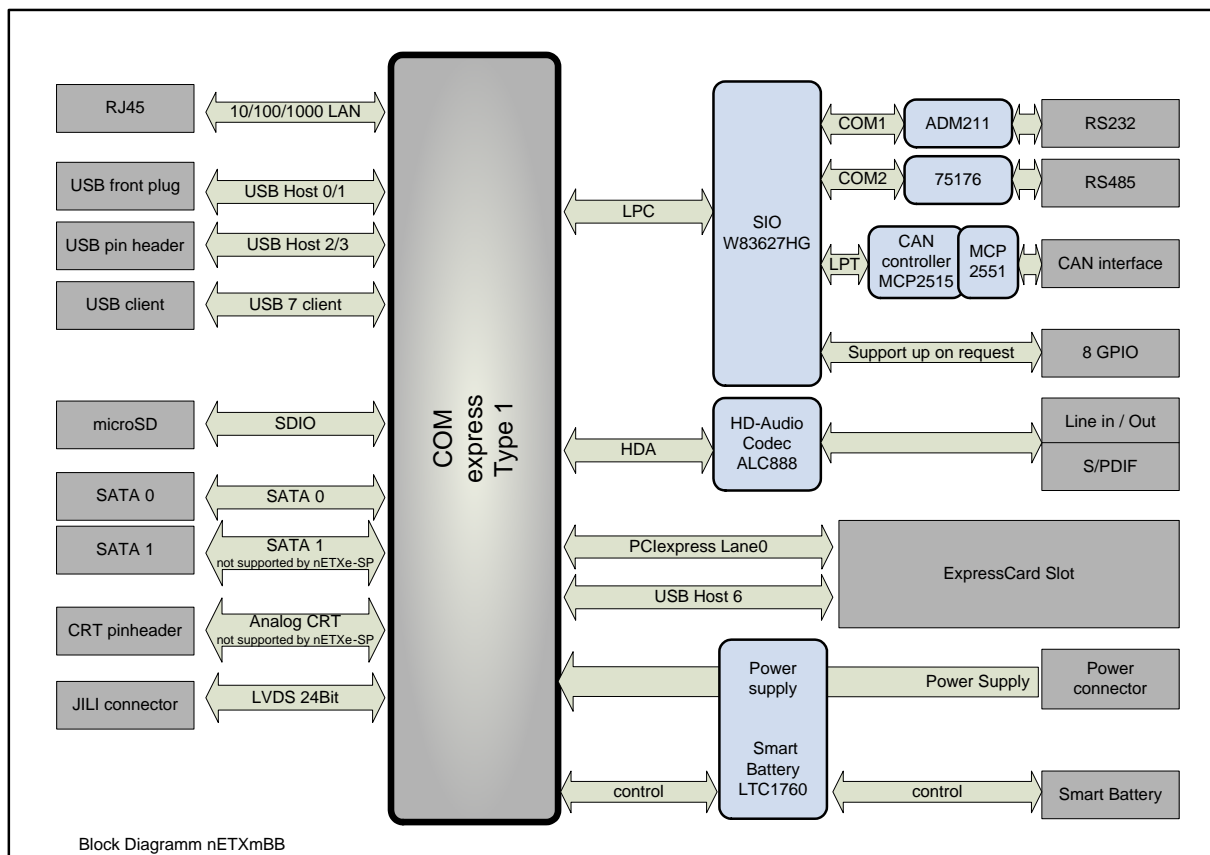

4.2 Connector layout and part placement

4.2.1 Top view

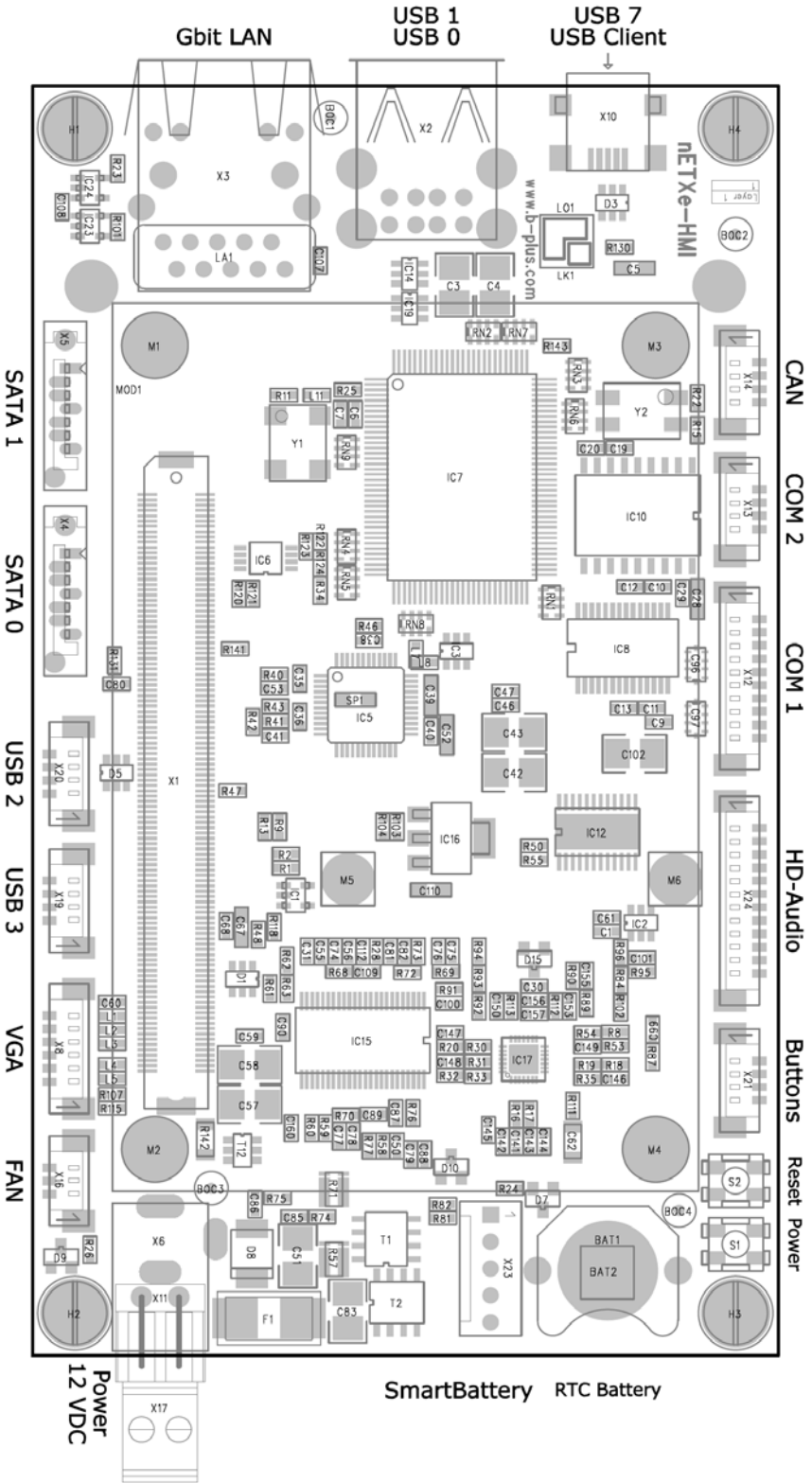

5 Connector and feature description

This chapter describes the naming and layout of all standard connectors, the pin out and functions of the onboard pin headers and the configuration jumpers and interfaces.

5.1 COM Express™ connector (X1)

The standard COM Express™ pin-out type 1 connector is fully compatible with the COM Express™ specification. Please refer to the specifications or module manuals on <http://www.kontron.com> for more details and pin out description.

The ePDAnano Baseboard can carry a full featured COM Express™ pin-out type 1 module following the new standard form factor nanoETXexpress (<http://www.kontron.com/nanoetxexpress>).

The COM Express™ pin-out type 1 connection via connector A/B defines the following feature set:

Table 5-1: COM Express(tm) connector on ePDAnano

Row A Functions	Row B Functions
Gigabit Ethernet	LPC
	SMB
SATA0, SATA2	SATA1, SATA3
Power Management	Audio, I2C
USB6, USB4	USB7, USB5
USB2, USB0	USB3, USB1
PCIe 0-5	PCIe 0-5
LVDS	LVDS
GPIO	VGA, TVout
VCC	VCC

5.2 USB

COM Express™ defines a maximum of 8 USB ports. On ePDAnano Baseboard 2 USB Ports (USB0 & USB1) are provided via front panel connector X2 and two (USB2 & USB3) ports via onboard connector (X20 & X19). USB Port 6 is used for Express Card.

5.2.1 USB Host 0/1 (X2)

Table 5-2: Pinning of X2

Connector: CON-F-USB/HOR2; MOLEX 67298-4091

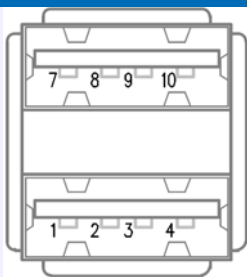
Header	PIN	Signal	Function	Note
	1	USB1_PWR	USB0 supply (max. 500 mA)	*
	2	USB1_D-	USB port 1 D-	
	3	USB1_D+	USB port 1 D+	
	4	GND	USB Ground	
	7	USB0_PWR	USB0 supply (max. 500 mA)	*
	8	USB0_D-	USB port 0 D-	
	9	USB0_D+	USB port 0 D+	
	10	GND	USB Ground	

Notes (*):

To protect the external power lines of peripheral devices, make sure that:

- the wires have the right diameter to withstand the maximum available current
- the enclosure of the peripheral device fulfils the fire-protecting requirements of IEC/EN 60950

The USB power lines are protected with a resettable fuse and are limited to 500mA.

5.2.2 USB Host 2 (X20)

Table 5-3: Pinning of X20

Connector: CON-MOLEX-53261-0471; Molex 53261-0471

Header	PIN	Signal	Function	Note
	1	GND	Ground	
	2	USB2_D+	USB port D+	
	3	USB2_D-	USB port D-	
	4	USB2_PWR	USB supply (max. 1 A)	

Cable: KAB-USB-1; 96054-0000-00-0

5.2.3 USB Host 3 (X19)

Table 5-4: Pinning of X19

Connector: CON-MOLEX-53261-0471; Molex 53261-0471

Header	PIN	Signal	Function	Note
	1	GND	Ground	
	2	USB3_D+	USB port D+	
	3	USB3_D-	USB port D-	
	4	USB3_PWR	USB supply (max. 1 A)	

Cable: KAB-USB-1; 96054-0000-00-0

5.2.4 USB Client (X10)

With nanoETXexpress a new function called USB Client is coming up. If supported by the used chipset on the module, USB Port7 is used as an USB Client connection via MiniUSB connector TypeA (X10). The client function is a software implemented USB device in the chipset which allows connecting the platform to other USB Host interfaces for purposes of file transfer, network connectivity or any other USB functions.

Table 5-5: Pinning of X10

Connector: CON-MOLEX-53261-0471; Molex 53261-0471

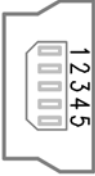
Header	PIN	Signal	Function	Note
	1	NC	Not connected	
	2	USB7_D+	USB Client port D+	
	3	USB7_D-	USB Client port D-	
	4	NC	Not connected	
	5	GND	Ground	

Refer to the module manual and download section of the used module for driver and software downloads for using the USB Client functionality.

Warning: Do not use the USB Client Port X10 for connecting any USB devices

Note: The availability of the Express Card USB function (USB6) and USB Client (USB7) depends on the module's specification. For the Express Card USB function a module with full USB support is necessary.

5.3 Ethernet (X3)

The Ethernet Port on ePDAnano is designed for Gigabit Ethernet modules. For modules with 10/100 MBit Ethernet connections please contact your local sales or support.

Table 5-6: Pinning of X10

Connector: CON-RJ45- 7499111441; Würth Elektronik 7499111441

Header	PIN	Signal	Function	Note	
	1	MX0+			
	2	MX0-			
	3	MX1+			
	4	MX2+			
	5	MX2-			
	6	MX1-			
	7	MX3+			
	8	MX3-			
	L	Left LED	Yellow = Link100; Green = Link1000		
	R	Right LED	Green = Activity		

Table 5-7: X3 LED function

LED	State	Function
1 (left)	Green	Link1000
	Yellow	Link100
	Off	Link10
2 (right)	Green	Link
	Blinking	Activity

5.4 SATA Ports

The ePDAnano baseboard provides 2 SATA channels. Please check how many SATA ports are supported by the used COM Express™ module.

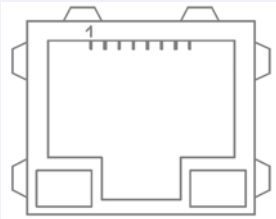
5.4.1 SATA0 (X4)

Table 5-2: Pinning of X4

Connector: CON-SATA-MOL-67491; Molex 67491-1030

Header	PIN	Signal	Function	Note
	1	GND		
	2	SATA0_TX+		
	3	SATA0_TX-		
	4	GND		
	5	SATA0_RX-		
	6	SATA0_RX+		
	7	GND		

5.4.2 SATA1 (X5)

Table 5-9: Pinning of X5

Connector: CON-SATA-MOL-67491; Molex 67491-1030

Header	PIN	Signal	Function	Note
	1	GND		
	2	SATA1_TX+		
	3	SATA1_TX-		
	4	GND		
	5	SATA1_RX-		
	6	SATA1_RX+		
	7	GND		

5.5 Express Card Socket (X7)

The onboard Express Card is connected to PCIexpress lane #0 and to USB port 6. To use the Express Card USB functions a COM Express™ module with at least 8 USB ports is necessary.

Table 5-10: Pinning of X7

Connector: CON-TYCO-1759056 + CON-TYCO-1759054

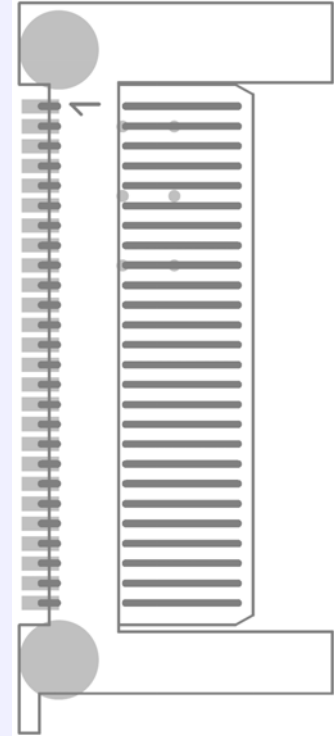
Header	PIN	Signal	Function	Note
	1	GND		
	2	USB_D-	USB6_D+	
	3	USB_D+	USB6_D+	
	4	CPUUSB#		
	5	RSVD_1		
	6	RSVD_0		
	7	SMB_CLK	SMBus Clock	1
	8	SMB_DAT	SMBus Data	2
	9	1.5V_1	managed V1.5_S0	
	10	1.5V_0	managed V1.5_S0	
	11	WAKE#	WAKE0#	
	12	3.3V_AUX	managed V3.3_S5	
	13	PERST#		
	14	3.3V_1	managed V3.3_S0	
	15	3.3V_0	managed V3.3_S0	
	16	CLKREQ#		
	17	CPPE#	EXTCDO#	
	18	REFCLK-		
	19	REFCLK+		
	20	GND		
	21	PER0-	PCIE_RX_0-	
	22	PER0+	PCIE_RX_0+	
	23	GND		
	24	PET0-	PCIE_TX_0-	
	25	PET0+	PCIE_TX_0+	
	26	GND		

Notes: 1: Normally not connected, for SMBus connection mount R64 [00hm]

2: Normally not connected, for SMBus connection mount R65 [00hm]

Connector X7 allows using both ExpressCard/34 and ExpressCard/54.

The maximum continuous card power is

- 1,3A on 3,3V
- 275mA on 3.3V_AUX
- 650mA on 1,5V

5.6 JILI (X9)

The integrated graphics of the COM Express™ module can be used via LVDS connector X9.

Table 5-11: Pinning of X9

Connector: CON-MOLEX-54104-4096; Molex 54104-4096

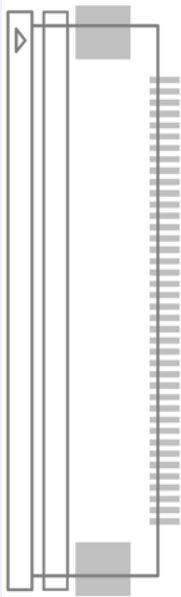
Header	PIN	Signal	Function	Note	
	1	BKLT_POW	12V power supply for panel backlight	1	
	2	BKLT_POW	12V power supply for panel backlight	1	
	3	BKLT_POW	12V power supply for panel backlight	1	
	4	GND			
	5	GND			
	6	LVDS_BKLT_EN_R			2
	7	PANEL_PWR	5,0V Power Supply for TFT panel		3
	8	PANEL_PWR	5,0V Power Supply for TFT panel		3
	9	PANEL_PWR	5,0V Power Supply for TFT panel		3
	10	PANEL_PWR	5,0V Power Supply for TFT panel		3
	11	LVDS_B3+			
	12	LVDS_B3-			
	13	GND			
	14	LVDS_B_CK+			
	15	LVDS_B_CK-			
	16	GND			
	17	LVDS_B2+			
	18	LVDS_B2-			
	19	GND			
	20	LVDS_B1+			
	21	LVDS_B1-			
	22	LVDS_I2C_CK			
	23	LVDS_B0+			
	24	LVDS_B0-			
	25	LVDS_I2C_DAT			
	26	LVDS_A3+			
	27	LVDS_A3-			
	28	GND			
	29	LVDS_A_CK+			
	30	LVDS_A_CK-			
	31	GND			
	32	LVDS_A2+			
	33	LVDS_A2-			
	34	NC		Not connected	
	35	LVDS_A1+			
	36	LVDS_A1-			
	37	LVDS_VDD_EN			
	38	LVDS_A0+			
	39	LVDS_A0-			
	40	LVDS_BKLT_CTRL			4

Notes: 1: BuiltIn StepUp converter to 12V, max. 500 mA
 2: Backlight Enable Signal, normally active low, mount R1 instead of R2 for active high signal
 3: Power supply for TFT panel, 5V, max. 500 mA
 4: Normally not connected, for PWM backlight control mount R118 00hm

Table 5-12: Kontron cables for display connection

For connection of ...	Cable or adapter
TFT PrimeView PM07OWL4 (video signal and backlight only)	KAB-ADAPT-LVDS; 61032 + KAB-JILI30-TSLD01; 62518
TFT PrimeView PM07OWL4 (touch)	Separate touch adapter required / complete solution available
DVI monitor	ADA-LVDS-DVI; 96007-0000-00-1

For a detailed description of the LVDS JILI interface refer to the JILI documentation on Kontron's webpage.

5.7 VGA Port (X8)

The integrated graphics of the COM Express™ module can be used by the analog DSUB15 VGA connector X8. Please check if the VGA port is supported by the used COM Express™ module.

Table 5 13: Pinning of X8

Connector: CON-MOLEX-53261-0671; Molex 53261-0671

Header	PIN	Signal	Function	Note
	1	HSYNC	VGA_HSYNC	
	2	VSYNC	VGA_VSYNC	
	3	GND	Ground	
	4	BLUE	VGA_BLUE	
	5	GREEN	VGA_GREEN	
	6	RED	VGA_RED	

Cable: KAB-VGA-2; 96053-0000-00-0

5.8 Serial Ports

The ePDAnano baseboard is equipped with an external LPC I/O Controller Winbond W83627HFJ for providing standard legacy connections like COM or LPT.

Note: For using the LPC-I/O functions like COM, LPT and hardware monitoring features, a COM Express™ module with legacy BIOS is necessary.

5.8.1 COM1 RS232 (X12)

Table 5-3: Pinning of X12

Connector: CON-MOLEX-53261-1071; Molex 53261-1071

Header	PIN	Signal	Function	Note
	1	NC	not connected	
	2	GND		
	3	COM1_RI#	Ring indicator	
	4	COM1_DTR#	Data terminal ready	
	5	COM1_CTS#	Clear to send	
	6	COM1_TXD	Transmit data	
	7	COM1_RTS#	Request to send	
	8	COM1_RXD	Receive data	
	9	COM1_DSR#	Data set ready	
	10	COM1_DCD#	Data carrier detect	

Cable: KAB-DSUB-3; 96061-0000-00-0

5.8.2 COM2 RS485 (X13)

Table 5-45: Pinning of X13

Connector: CON-MOLEX-53261-1071; Molex 53261-1071

Header	PIN	Signal	Function	Note
	1	GND		
	2	NC	not connected	1
	3	A	Data B	
	4	B	Data B	

Notes: 1: Normally not connected, mount R15 00hm to power external logic with 5V, max 100mA recommended

Cable: KAB-CAN-1; 96065-0000-00-0 (suitable for RS485 as well!)

5.9 CAN (X14)

Table 5-5: Pinning of X14

Connector: CON-MOLEX-53261-0471; Molex 53261-0471

Header	PIN	Signal	Function	Note
	1	GND		
	2	NC	not connected	1
	3	CAN_H	CAN high	
	4	CAN_L	CAN low	

Notes: 1: Normally not connected, mount R22 00hm to power external logic with 5V, max 100mA recommended

Cable: KAB-CAN-1; 96065-0000-00-0

5.10 microSD Socket (X15)

COM Express™ defines a maximum of 4GPIs and 4 GPOs. With the new nanoETXexpress standard the 8 General Purpose Input/Output signals alternatively can be configured as SDIO interface. Refer to the module's manual if SD Card feature is supported and how it is to be configured.

Table 5 17: Pinning of X15

Connector: CON-MICROSD-MOLEX-49225-0811; Molex 49225-0811

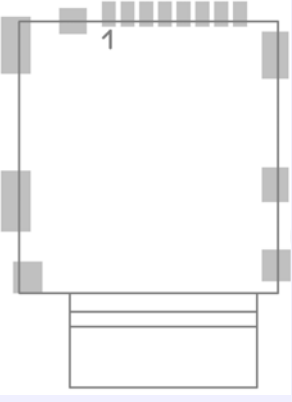
Header	PIN	Signal	Function	Note
	1	DAT2	SD_DATA2	
	2	DAT3/CD	SD_DATA3	
	3	CMD	SD_CMD	
	4	VDD		
	5	CLK	SD_CLK	
	6	GND		
	7	DAT0	SD_DATA0	
	8	DAT1	SD_DATA1	
	9	CD-SW1	SD_CD#	
	10	CD-SW2	GND	

5.11 FAN (X16)

The Winbond 83627HG LPC-I/O Controller provides an internal hardware monitor and a FAN connection.

Note: To support FAN control and monitoring it is required to set the LPC decode range 1 base to 290h and the range 1 size to 8B in the module BIOS. Refer to the module's manual for more details.

Table 5 18: Pinning of X16

Connector: CON-MOLEX-53261-0371; Molex 53261-0371

Header	PIN	Signal	Function	Note
	1	FANI01	Tacho Signal from Fan	
	2	FANPWM1	PWM controlled Fan Power	1
	3	GND		

Notes: 1: Normally R106 is mounted for 12V fan, for 5V fan mount R105 00hm instead of R106

5.12 GPIO (X18)

The Winbond 83627HG LPC-I/O Controller provides 8 bit GPIO (Gamepad port)

Table 5 19: Pinning of X18

Connector: CON-MOLEX-53261-1071; Molex 53261-1071

Header	PIN	Signal	Function	Note
	1	GND		
	2	V5.0_S0		
	3	GP10		
	4	GP11		
	5	GP12		
	6	GP13		
	7	GP14		
	8	GP15		
	9	GP16		
	10	GP17		

Notes: 1: not fused, max 100mA allowed

Warning: These signals are not protected against overvoltage, overcurrent and ESD discharge.

These signals are directly connected to the LPC-I/O Controller.

5.13 Power (X6)

Table 5-6: Pinning of X6

Connector: DC10A

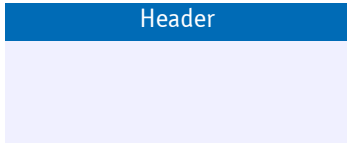
Header	PIN	Signal	Function	Note
	1	V_DCIN	+12 V power supply input	
	2	GND		
	3	GND		

Use a DC wall adapter with a voltage range of 9,6V to 14V and a standard plug with 5,5 x 2,1 x 9,5 mm.

5.14 External Buttons (X21)

Table 5-7: Pinning of X21

Connector: CON-MOLEX-53261-0471; Molex 53261-0471

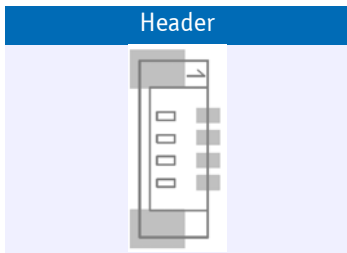
Header	PIN	Signal	Function	Note
	1	V3.3_S5	3,3V standby power supply	1
	2	PWRBTN#	System PWR On/Off	
	3	SYS_RESET#	System Reset	
	4	GND		

Notes: 1: not fused, max 100mA allowed

5.15 SmartBattery (X23)

Table 5-8: Pinning of X23

Connector: CON-M-1X5-MOLEX- 22-27-2051; Molex 22-27-2051

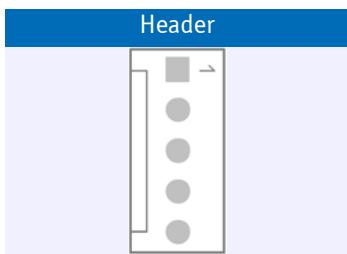
Header	PIN	Signal	Function	Note
	1	GND		
	2	TH_B1	Thermistor	
	3	SDA_B1	SMB DAT	
	4	SCL_B1	SMB CLK	
	5	V_B1		1

Notes: 1: use 2 cell battery with nominal 7,2 V; max. charge current 2 A

5.16 Audio (X24)

The ePDAnano baseboard is equipped with a Realtek ALC888 High Definition Audio Codec which supports 2-channel speaker configuration, optical and digital S/PDIF out and S/PDIF in.

Table 5 23: Pinning of X24

Connector: CON-MOLEX-53261-1271; Molex 53261-1271

Header	PIN	Signal	Function	Note
	1	V5.0	power supply for S/PDIF	1
	2	S/PDIF_RX	S/PDIF Receive	
	3	GND	Digital Ground for S/PDIF	
	4	S/PDIF_TX	S/PDIF Transmit	
	5	LINE1_JD	Line 1 Jack Detect	2
	6	LINEIN_L	LineIn left	
	7	LINEIN_R	LineIn right	
	8	AGND	Analog Audio Ground	
	9	LINE2_JD	Line 2 Jack Detect	2
	10	HPOUT_L	Headphone/LineOut left	
	11	HPOUT_R	Headphone/LineOut right	
	12	AGND	Analog Audio Ground	

Notes: 1: not fused, max 100mA allowed
2: used to detect a connected audio device

TIP: Use HD-Audio-Connector-Board 34110-0000-00-0, see Chapter 9

In addition to the default speaker settings, the analog audio jacks can be reconfigured to perform different functions via the Realtek HDAudio driver software which is available at the Kontron website.

Audio only works in combination with HD Audio compatible COM Express™ modules.

6 Battery Information (BAT1)

The ePDAnano Baseboard includes a CR1225 3V RTC battery

English:

CAUTION: *Danger of explosion if battery is incorrectly replaced. Replace only with the same or equivalent type recommended by the manufacturer. Dispose of used batteries according to the manufacturer's instructions.*

Deutsch:

VORSICHT: *Explosionsgefahr bei unsachgemäßem Austausch der Batterie. Ersatz nur durch denselben oder einen vom Hersteller empfohlenen gleichwertigen Typ. Entsorgung gebrauchter Batterien nach Angaben des Herstellers.*

French:

ATTENTION: *Risque d'explosion avec l'échange inadéquat de la batterie. Remplacement seulement par le même ou un type équivalent recommandé par le producteur. L'évacuation des batteries usagées conformément à des indications du fabricant.*

Danish:

ADVARSEL: *Lithiumbatteri – Eksplosionsfare ved fejlagtig Håndtering. Udskifting må kun ske med batteri af samme fabrikant og type. Lever det brugte batteri tilbage til leverandøren.*

Finnish:

VAROITUS: *Paristo voi räjähtää, jos se on virheellisesti asennettu. Vaihda paristo ainoastaanlaltevalmistajan suosittelmaan tyyppiin. Havita käytetty paristo valmistajan ohjeiden mukaisesti.*

Spanish:

Precaución: *Peligro de explosión si la batería se sustituye incorrectamente. Sustituya solamente por el mismo o tipo equivalente recomendado por el fabricante. Disponga las baterías usadas según las instrucciones del fabricante.*

Note: *The battery of this product is not considered to be accessible by the end user. Therefore the safety instructions are only given in English, German, French, Danish, Finish and Spanish language. If the battery of this product however is accessible by the end user, it is in the responsibility of the Kontron customer to give the corresponding safety instructions in the required language(s).*

7 Security advice

To protect the external power lines to peripheral devices the customer has to take care about:

- The wires to the external device have the right diameter to withstand the max. available current*
 - The housing of the external device fulfils the fire protection requirements of IEC/EN 60950.*
-

8 Smart Battery system and dual buck converter

8.1 Introduction

The Core of the SBS is the dual Smart Battery System Manager LTC1760. On the ePDAnano baseboard only one battery connection is provided.

Smart Battery Systems have the ability to communicate with the application. Therefore the user gets information about the current state of the battery. The interface for this communication is the System Management Bus (SMBus). Standard Smart Batteries have a specified 5 pin header, connecting to the power lines and additionally this SMBus. This standardization allows using all available kinds of standard Smart Batteries, which also applies to the ePDAnano baseboard.

A typical SBS consists of a Smart Battery System Manager and a charger, which can communicate with the chipset using the SMBus. If there is no software to control the SBS via SM-bus then the system is able to run in a stand alone mode with reduced functionality, too.

The SBS was designed for the requirements of the ePDAnano Baseboard. Therefore the input voltage can be supplied with a DC wall adapter in a range of 9,6V to 14V. Additionally different kinds of Smart Batteries can be used. That means different battery chemistry and cell configurations. But it must be ensured to use standard Smart Batteries, which meet the SM-Bus standard.

8.2 Possible Smart Batteries

The SBS hardware is configured for a maximum charger output voltage of 8,4V and a maximum output current of 2 A. Smart Batteries with a nominal voltage of 7,2V, e.g. NiMH and NiCd with 6SxP (= 6 cells in series and x in parallel) or Li-Ion and LiPo with 2SxP (= 2 cells in series and x in parallel) are possible.

Battery Manufacturer:

http://www.moltechpower.co.uk/smart_standard_range.htm

e.g. ND2057, NH2057

http://www.inspired-energy.com/Standard_Products/standard_products.htm

http://www.emergingpower.com/oem/oem_standardpacks.htm

8.3 Smart Battery System Manager

The LTC1760 SBS Manager is a highly integrated level 3 battery charger and selector intended for products using dual smart batteries. Three SMBus interfaces allow the LTC1760 to servo to the internal voltage and currents measured by the batteries while allowing a SMBus Host to monitor either battery's status. Charging accuracy is determined by the battery's internal voltage and current measurement, typically better than $\pm 0,2\%$.

The LTC1760 automatically switches between power sources in less than 10 μ s to prevent power interruption upon battery or wall adapter removal. It implements all elements of a version 1.1 “Smart Battery System Manager” except for the generation of composite battery information. An internal multiplexer cleanly switches the SMBus Host to the attached Smart Battery without generating partial messages to the battery or SMBus host. The Thermistor on the battery is automatically monitored for temperature and disconnection information (SafetySignal).

Hardware programmable limits for maximum charge current and voltage improve the safety of the complete system. For more information see datasheet of LTC1760.

- **LOPWR TRIP**
The threshold voltage controls the voltage which source the system. When the voltage of the active source drops below this threshold, then the currently best voltage source is selected. This threshold voltage is configured to 5,95 V.
- **VLIMIT**
The maximum charging voltage is configured to 8,4 V. This limit provides a measure of safety with a hardware restriction and charging voltage, which cannot be overridden by software. This voltage sets the limit that will be applied to the battery as reported by battery.
- **ILIMIT**
The maximum charging current is configured to 2 A. This limit was set to decrease the charger hardware.

8.4 Dual Buck Converter

The dual buck converter is used, to generate 5 V and 3,3 V, to source the system. On the ePDAnano Baseboard the LTC3850 is used for this function. The 5 V path provides a maximum current of 6 A and the 3,3 V path a maximum of 3 A.

9 HD-Audio-Connector-Board; 34110-0000-00-0

9.1 Mechanical Specifications:

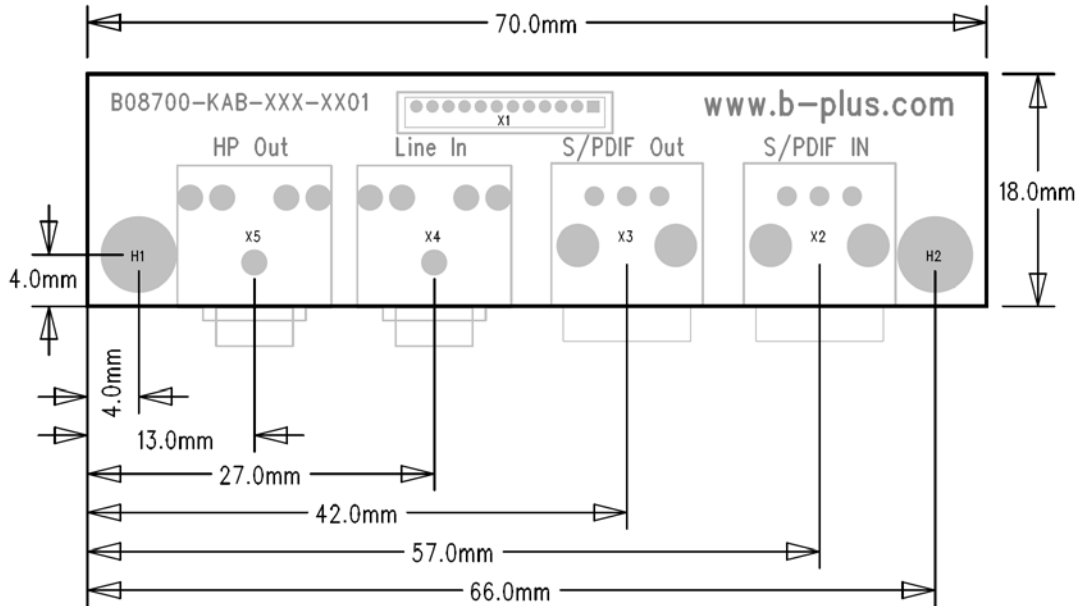

9.2 Connector Description:

Table 8 1: Description of X1-X5 (34110-0000-00-0)

Pos.	Function	Description	Note
X1	HD-Audio	connection to ePDAnano baseboard	1
X2	S/PDIF IN	Toslink, TORX147L, fiber optic receiving module	
X3	S/PDIF OUT	Toslink, TOTX147L, fiber optic transmitting module	
X4	Line IN	3,5mm jack, stereo line in	
X5	HP Out	3,5mm jack, stereo line out, stereo headphone out	

Note 1: -connector CON-MOLEX-53047-1210; Molex 53047-1210
 -pin 1 marked with circle
 -same pinning as shown in chapter 3.16
 - the jack detect signal on pins (5 and 9) are connected directly to AGND

10 CAN controller

10.1 Introduction

The schematic is almost identical with the MCP2515 Development Kit from Microchip.

The LPT port of IC7 (Super-I/O) is the link between the CAN controller MCP2515 and the COM Express™ Module that acts as a microcontroller. The parallel port is used to allow the PC to communicate with MCP2515 via SPI.

The CAN controller MCP2515 is the interface between the CAN bus and the MCU.

The CAN transceiver MCP2551 converts the differential signal on the bus to digital levels for the CAN controller and vice versa.

10.2 Further information

Free evaluation software is available from Microchip:

<http://ww1.microchip.com/downloads/en/DeviceDoc/mcp2515devkit.zip>

User's Guide for MCP2515 Development Kit from Microchip:

<http://ww1.microchip.com/downloads/en/DeviceDoc/51416a.pdf>

For further information see the homepage of Microchip's MCP2510/2515 CAN Developer's Kit, DV251001:

http://www.microchip.com/stellent/idcplg?IdcService=SS_GET_PAGE&nodeId=1406&dDocName=en531891

11 Optional features

The b-plus ePDAnano baseboard was designed for the first available Kontron nanoETXexpress module nanoETXexpress-SP. So the following features on the baseboard can be adjusted for making the whole platform better suitable for an industrial application. Please contact the support if you require one of these options in a series application with ePDAnano.

11.1 ATX mode / AT mode

It is not possible to configure a “Last Power State” or “Always On” in the BIOS because the nanoETXexpress-SP module makes an automatic detection of ATX or AT mode. The ePDAnano is configured for ATX mode by default. This means that the power button must be pushed to boot the module.

To manually configure the AT mode a small hardware change is necessary.

- remove R48 -> to cut off the standby voltage to the module
- remove R98 and solder it on position R140 -> all peripheral systems are permanently enabled

11.2 Optional Power Connector

The alternative power connector has greater pull out forces and is recommended for industrial environments.

The DC10A power connector X6 can be replaced by these positions:

X11	CON-PHOENIX-MC1.5/2-G-3.5	MC 1,5/ 2-G-3,5	1844210	Phoenix Contact	RM 3,5 mm
X17	CON-PHOENIX-MC1.5/2-ST-3.5	MC 1,5/ 2-ST-3,5	1840366	Phoenix Contact	RM 3,5 mm

11.3 Disclaimer for customer modifications

All modifications described in chapter 10 are done by the customers at own risk. Kontron or b-plus does not guarantee for correct function.

12 Recommended Cables

12.1 KAB-CAN-1; 96065-0000-00-0

This cable can be used for the COM2 RS485 Port X13 and the CAN Port X14.

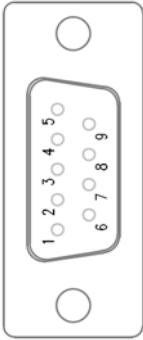
Header	PIN	Signal	Function	Note
 DSUB9, male	1	NC	not connected	
	2	B / CAN_L	RS485-B / CAN low	1
	3	GND		
	4	NC	not connected	
	5	NC	not connected	
	6	NC	not connected	
	7	A / CAN_H	RS485-A / CAN high	1
	8	NC	not connected	
	9	NC	not connected	

Notes: 1: There is no 120 Ohm termination mounted, neither on the baseboard, nor in the KAB-CAN-1

12.2 KAB-DSUB-3; 96061-0000-00-0

This cable can be used for the COM1 RS232 Port X12.

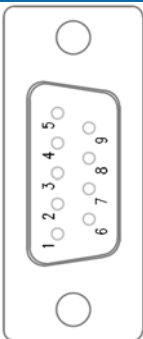
Header	PIN	Signal	Function	Note
 DSUB9, male	1	DCD	Data carrier detect	
	2	RXD	Receive data	
	3	TXD	Transmit data	
	4	DTR	Data terminal ready	
	5	GND		
	6	DSR	Data set ready	
	7	RTS	Request to send	
	8	CTS	Clear to send	
	9	RI	Ring indicator	

12.3 KAB-VGA-2; 96053-0000-00-0

This cable can be used for the VGA Port X8.

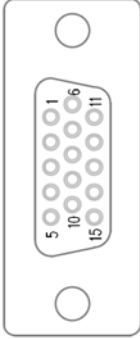
Header	PIN	Signal	Function	Note
 <p>HDSUB15, female</p>	1	RED		
	2	GREEN		
	3	BLUE		
	4	NC	not connected	
	5	GND		
	6	GND		
	7	GND		
	8	GND		
	9	NC	not connected	
	10	GND		
	11	NC	not connected	
	12	NC	not connected	
	13	HSYNC		
	14	VSYNC		
	15	NC	not connected	

12.4 KAB-USB-1; 96054-0000-00-0

This cable can be used for the USB2 Port X20 and the USB3 Port X19.

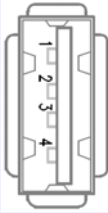
Header	PIN	Signal	Function	Note
	1	USB_PWR	USB supply	
	2	USB_D-	USB port D-	
	3	USB_D+	USB port D+	
	4	GND		

13 Document History

Rev.	Date	Edited by	Changes
0.10_prelim	20.01.2009	MHI, b-plus	Initial Release
0.11_prelim	30.01.2009	MHI, b-plus	Added 3.2, updated 5.16 and 9
1.10	10.02.2009	PRO, Kontron	Changed to Kontron layout
1.11	16.03.2009	PRO, Kontron	Corrected Part No. for HD-Audio-Connector on page 27 Updated Storage Temperature