



Control Unit CUmini 5x-2x0x

Doc. Rev. 1.A

Doc. ID: 90212 (EN)

This page has been intentionally left blank.

▶ CONTROL UNIT CUMINI 5X-2X0X - USER GUIDE

Disclaimer

Kontron would like to point out that the information contained in this user guide may be subject to alteration, particularly as a result of the constant upgrading of Kontron products. This document does not entail any guarantee on the part of Kontron with respect to technical processes described in the user guide or any product characteristics set out in the user guide. Kontron assumes no responsibility or liability for the use of the described product(s), conveys no license or title under any patent, copyright or mask work rights to these products and makes no representations or warranties that these products are free from patent, copyright or mask work right infringement unless otherwise specified. Applications that are described in this user guide are for illustration purposes only. Kontron makes no representation or warranty that such application will be suitable for the specified use without further testing or modification. Kontron expressly informs the user that this user guide only contains a general description of processes and instructions which may not be applicable in every individual case. In cases of doubt, please contact Kontron.

This user guide is protected by copyright. All rights are reserved by Kontron. No part of this document may be reproduced, transmitted, transcribed, stored in a retrieval system, or translated into any language or computer language, in any form or by any means (electronic, mechanical, photocopying, recording, or otherwise), without the express written permission of Kontron. Kontron points out that the information contained in this user guide is constantly being updated in line with the technical alterations and improvements made by Kontron to the products and thus this user guide only reflects the technical status of the products by Kontron at the time of publishing.

Brand and product names are trademarks or registered trademarks of their respective owners.

©2020 Kontron S&T AG

Kontron S&T AG

Lise-Meitner-Str. 3-5

86156 Augsburg

Germany

www.kontron.com

Intended Use

THIS DEVICE AND ASSOCIATED SOFTWARE ARE NOT DESIGNED, MANUFACTURED OR INTENDED FOR USE OR RESALE FOR THE OPERATION OF NUCLEAR FACILITIES, THE NAVIGATION, CONTROL OR COMMUNICATION SYSTEMS FOR AIRCRAFT OR OTHER TRANSPORTATION, AIR TRAFFIC CONTROL, LIFE SUPPORT OR LIFE SUSTAINING APPLICATIONS, WEAPONS SYSTEMS, OR ANY OTHER APPLICATION IN A HAZARDOUS ENVIRONMENT, OR REQUIRING FAIL-SAFE PERFORMANCE, OR IN WHICH THE FAILURE OF PRODUCTS COULD LEAD DIRECTLY TO DEATH, PERSONAL INJURY, OR SEVERE PHYSICAL OR ENVIRONMENTAL DAMAGE (COLLECTIVELY, "HIGH RISK APPLICATIONS").

You understand and agree that your use of Kontron devices as a component in High Risk Applications is entirely at your risk. To minimize the risks associated with your products and applications, you should provide adequate design and operating safeguards. You are solely responsible for compliance with all legal, regulatory, safety, and security related requirements concerning your products. You are responsible to ensure that your systems (and any Kontron hardware or software components incorporated in your systems) meet all applicable requirements. Unless otherwise stated in the product documentation, the Kontron device is not provided with error-tolerance capabilities and cannot therefore be deemed as being engineered, manufactured or setup to be compliant for implementation or for resale as device in High Risk Applications. All application and safety related information in this document (including application descriptions, suggested safety measures, suggested Kontron products, and other materials) is provided for reference only.

Revision History

Revision	Brief Description of Changes	Date of Issue	Author/ Editor
0.A	Initial Issue	31.01.2020	GUGMA
0.B	11529 added; LED & Powerbutton changed	16.07.2020	GUGMA
0.C	Appendix B added and additional safety warning	25.09.2020	KEPRA
0.D	Added temperature requirement for power cable	14.10.2020	KEPRA
1.A	Female connector X1 with UL/CSA conformity	24.02.2021	KEPRA

Terms and Conditions

Kontron warrants products in accordance with defined regional warranty periods. For more information about warranty compliance and conformity, and the warranty period in your region, visit <http://www.kontron.com/terms-and-conditions>.

Kontron sells products worldwide and declares regional General Terms & Conditions of Sale, and Purchase Order Terms & Conditions. Visit <http://www.kontron.com/terms-and-conditions>.

For contact information, refer to the corporate offices contact information on the last page of this user guide or visit our website [CONTACT US](#).

Customer Support

Find Kontron contacts by visiting: <http://www.kontron.com/support>.

Customer Service

As a trusted technology innovator and global solutions provider, Kontron extends its embedded market strengths into a services portfolio allowing companies to break the barriers of traditional product lifecycles. Proven product expertise coupled with collaborative and highly-experienced support enables Kontron to provide exceptional peace of mind to build and maintain successful products.

For more details on Kontron's service offerings such as: enhanced repair services, extended warranty, Kontron training academy, and more visit <http://www.kontron.com/support-and-services/services>.

Customer Comments

If you have any difficulties using this user guide, discover an error, or just want to provide some feedback, contact [Kontron support](#). Detail any errors you find. We will correct the errors or problems as soon as possible and post the revised user guide on our website.

Symbols

The following symbols may be used in this user guide

DANGER

DANGER indicates a hazardous situation which, if not avoided, will result in death or serious injury.

WARNING

WARNING indicates a hazardous situation which, if not avoided, could result in death or serious injury.

NOTICE

NOTICE indicates a property damage message.

CAUTION

CAUTION indicates a hazardous situation which, if not avoided, may result in minor or moderate injury.



Electric Shock!

This symbol and title warn of hazards due to electrical shocks (>60V) when touching products or parts of products. Failure to observe the precautions indicated and/or prescribed by the law may endanger your life/health and/or result in damage to your material.



ESD Sensitive Device!

This symbol and title inform that the electronic boards and their components are sensitive to static electricity. Care must therefore be taken during all handling operations and inspections of this product in order to ensure product integrity at all times.



HOT Surface!

Do NOT touch! Allow to cool before servicing.



Laser!

This symbol inform of the risk of exposure to laser beam and light emitting devices (LEDs) from an electrical device. Eye protection per manufacturer notice shall review before servicing.



This symbol indicates general information about the product and the user guide.

This symbol also indicates detail information about the specific product configuration.



This symbol precedes helpful hints and tips for daily use.

For Your Safety

Your new Kontron product was developed and tested carefully to provide all features necessary to ensure its compliance with electrical safety requirements. It was also designed for a long fault-free life. However, the life expectancy of your product can be drastically reduced by improper treatment during unpacking and installation. Therefore, in the interest of your own safety and of the correct operation of your new Kontron product, you are requested to conform with the following guidelines.

⚠ WARNING

All operations on this product must be carried out by sufficiently skilled personnel only.

⚠ WARNING

If the equipment is used in a manner not specified by the manufacturer, the protection provided by the equipment may be impaired.

Safety instructions for mains-operated devices

As a precaution and in case of danger, the power connector must be easily accessible. The power connector is the product's main disconnect device.

⚠ CAUTION



Electric Shock!

Before installing a non hot-swappable Kontron product into a system always ensure that your mains power is switched off. Serious electrical shock hazards can exist during all installation, repair, and maintenance operations on this product. Therefore, always unplug the power cable and any other cables which provide external voltages before performing any work on this product.

Earth ground connection to a central grounding point shall remain connected. The earth ground cable shall be the last cable to be disconnected or the first cable to be connected when performing installation or removal procedures on this product.

Special Handling and Unpacking Instruction

NOTICE



ESD Sensitive Device!

Electronic boards and their components are sensitive to static electricity. Therefore, care must be taken during all handling operations and inspections of this product, in order to ensure product integrity at all times.

Do not handle this product out of its protective enclosure while it is not used for operational purposes unless it is otherwise protected.

Whenever possible, unpack or pack this product only at EOS/ESD safe work stations. Where a safe work station is not guaranteed, it is important for the user to be electrically discharged before touching the product with his/her hands or tools. This is most easily done by touching a metal part of your system housing.

If the product contains batteries for RTC or memory backup, ensure that the product is not placed on conductive surfaces, including anti-static plastics or sponges. They can cause short circuits and damage the batteries or conductive circuits on the product.

Lithium Battery Precautions

If your product is equipped with a lithium battery, take the following precautions when replacing the battery.

⚠ CAUTION

Danger of explosion if the battery is replaced incorrectly.

- ▶ Replace only with same or equivalent battery type recommended by the manufacturer.
- ▶ Dispose of used batteries according to the manufacturer's instructions.

General Instructions on Usage

In order to maintain Kontron's product warranty, this product must not be altered or modified in any way. Changes or modifications to the product, that are not explicitly approved by Kontron and described in this user guide or received from Kontron Support as a special handling instruction, will void your warranty.

This product should only be installed in or connected to systems that fulfill all necessary technical and specific environmental requirements. This also applies to the operational temperature range of the specific board version that must not be exceeded. If batteries are present, their temperature restrictions must be taken into account.

In performing all necessary installation and application operations, only follow the instructions supplied by the present user guide.

Keep all the original packaging material for future storage or warranty shipments. If it is necessary to store or ship the product then re-pack it in the same manner as it was delivered.

Special care is necessary when handling or unpacking the product. See Special Handling and Unpacking Instruction.

Quality and Environmental Management

Kontron aims to deliver reliable high-end products designed and built for quality, and aims to complying with environmental laws, regulations, and other environmentally oriented requirements. For more information regarding Kontron's quality and environmental responsibilities, visit <http://www.kontron.com/about-kontron/corporate-responsibility/quality-management>.

Disposal and Recycling

Kontron's products are manufactured to satisfy environmental protection requirements where possible. Many of the components used are capable of being recycled. Final disposal of this product after its service life must be accomplished in accordance with applicable country, state, or local laws or regulations.

WEEE Compliance

The Waste Electrical and Electronic Equipment (WEEE) Directive aims to:

- ▶ Reduce waste arising from electrical and electronic equipment (EEE)
- ▶ Make producers of EEE responsible for the environmental impact of their products, especially when the product become waste
- ▶ Encourage separate collection and subsequent treatment, reuse, recovery, recycling and sound environmental disposal of EEE
- ▶ Improve the environmental performance of all those involved during the lifecycle of EEE



Environmental protection is a high priority with Kontron.

Kontron follows the WEEE directive

You are encouraged to return our products for proper disposal.

Table of Contents

Symbols	6
For Your Safety	7
Safety instructions for mains-operated devices.....	7
Special Handling and Unpacking Instruction	7
Lithium Battery Precautions.....	8
General Instructions on Usage	8
Quality and Environmental Management	8
Disposal and Recycling.....	8
WEEE Compliance.....	8
Table of Contents	9
List of Tables	10
List of Figures	10
1/ Product overview	11
2/ Technical data	13
2.1. Dimensions and weight.....	13
2.2. Environmental conditions	13
2.3. Power supply	14
2.4. Materials	15
2.5. Type Label and Product Identification	15
2.6. Accessories.....	16
3/ Design and function	17
3.1. Description of function.....	17
3.1.1. Processor	17
3.1.2. BIOS	17
3.1.3. NOR-Flash.....	17
3.1.4. DDR3L RAM.....	17
3.1.5. MicroSD	17
3.1.6. eMMC.....	18
3.1.7. SRAM / FRAM	18
3.1.8. Power Management and Power Button	18
3.1.9. Thermal Management	19
3.1.10. RTC.....	19
3.1.11. Watchdog	19
3.1.12. Ethernet.....	19
3.2. Pin assignment.....	20
3.2.1. Status LEDs.....	21
3.2.2. Power Button.....	21
3.2.3. Power supply Connector X1.....	21
3.2.4. Ethernet connector X2 and X3.....	22
3.2.5. HDMI connector X7	22
3.2.6. USB 2.0 Host: connector X4.....	22
4/ Assembly and installation	23
4.1. DIN rail mounting	24
5/ Commissioning	25
5.1. Power supply.....	25
5.2. Grounding.....	25

5.3. Operating system	25
5.3.1. Microsoft Windows 10 IoT Enterprise.....	25
5.3.2. Linux	25
5.4. System configuration with Linux Debian	25
5.5. HTML5 Browser with Linux Debian	26
5.6. Soft-PLC CODESYS with Linux Debian	26
5.7. CODESYS Visualizations with Linux Debian	26
5.8. Backup/Restore the system (Live System).....	27
6/ Maintenance	28
6.1. Battery replacement.....	28
6.2. Cleaning.....	29
7/ Malfunctions	30
8/ Decommissioning and disposal.....	31
9/ Technical drawings	32
9.1. Views and dimensions.....	32
10/Technical Support.....	33
10.1. Warranty	33
10.2. Returning Defective Merchandise	34
Appendix A: List of Acronyms.....	35
Appendix B: Product Configurations.....	36
About Kontron	40

List of Tables

Table 1: Product Versions.....	11
Table 2: Detail configuration of the product versions:	11
Table 3: Zubehör for the Control Unit.....	16
Table 4: Possible processors.....	17
Table 5: Power Management Energy States (ACPI).....	18
Table 6: Power Button Function	19
Table 7: Signaling Ethernet Interface status.....	19
Table 8: Interfaces	20
Table 9: Status LEDs.....	21
Table 10: Power supply Connector X1.....	21
Table 11: Ethernet connector X2 and X3.....	22
Table 12: Malfunctions.....	30
Table 13: List of used Acronyms	35

List of Figures

Figure 1: Type Label.....	15
Figure 2: Interfaces/Connectors Front side	20
Figure 3: Interfaces/Connectors Back side.....	20
Figure 4: Mounting and dismounting a Control Unit on a DIN rail	24
Figure 5: Battery replacement	28
Figure 6: Views and dimensions	32

1/ Product overview

The CUmini 5x-2x0x Control Units were designed for industrial use and for very long availability. With the single to quad core versions and customer-specific adaptable memory, the Control Units are optimally scalable.

They are available with WIN10IoT or Linux with optional soft PLC CODESYS.

This manual is applicable to the product platform "CUmini". This compact industrial computer with Intel Atom processor can be manufactured in various configurations. The product key 5x-2x0x-xxxxx defines the configuration and is explained in Appendix B.

The product versions listed in **Table 1** are in production. Other versions are available upon request (minimum order quantities apply). For details please contact our sales team.

Table 1: Product Versions

Article No.	Name	Versions
11529	Control Unit CUmini 54-2500-48021	Compact Control Unit with Intel Atom E3845
11592	Control Unit CUmini 54-2500-58521	Compact Control Unit with Intel Atom E3845 with FRAM
11524	Control Unit CUmini 52-2500-47021	Compact Control Unit with Intel Atom E3825

Table 2: Detail configuration of the product versions

Version	11529	11592	11524	
on Board				
Intel Atom E3815 1.46GHz Single Core Processor				
Intel Atom E3825 1.33GHz Dual Core Processor			x	
Intel Atom E3845 1.91GHz Quad Core Processor	x	x		
SO-DIMM Slot	x	x	x	
DDR3L RAM 2GByte	x		x	
DDR3L RAM 4GByte		x		
eMMC 16GByte			x	
eMMC 32GByte	x	x		
eMMC 64GByte				
SRAM up to 128kByte [†]				
FRAM up to 512kByte [†]		128kB		
ENET 10/100/1000 Mbit Ethernet	2	2	2	
RTC	x	x	x	
WDT	x	x	x	
UEFI BIOS	x	x	x	
USB 2.0 Host	2	2	2	
HDMI	x	x	x	
microSD Card Slot	x	x	x	
Power Button	x	x	x	
Status LED (programmable)	x	x	x	

Operating system				
Microsoft Windows 10 IoT Enterprise license				
Linux Debian				
Software				
Soft-PLC CODESYS Runtime system license				
Soft-PLC CODESYS Target-Visu license				
Soft-PLC CODESYS Web-Visu license				
Mechanik				
Stainless steel housing with DIN rail clamp	x	x	x	
Mounting type vertical (book form)	x	x	x	
Mounting type horizontal				

†: Function only supported with Linux.

2/ Technical data

Depending on the version, the Control Unit can have the following properties (existing versions see 1/Product overview)

- ▶ Intel Atom E38xx processor of your choice:
 - ▶ E3815 with 1.46GHz Single-Core x86 processor
 - ▶ E3825 with 1.33GHz Dual-Core x86 processor
 - ▶ E3845 with 1.91GHz Quad-Core x86 processor
- ▶ up to 128 GByte eMMC Flash memory
- ▶ up to 8 GByte DDR3 RAM
- ▶ static memory (NV RAM) of your choice:
 - ▶ SRAM up to 128kByte
 - ▶ FRAM up to 512kByte
- ▶ Slot for microSD FlashCards up to SDXC format
- ▶ up to two independent Gigabit Ethernet interfaces on RJ45 (8P8C) connectors
- ▶ up to two USB Host interfaces on 4-pol. USB plug type A
- ▶ one HDMI on HDMImini connector
- ▶ battery-supported, processor-independent real-time clock (RTC)
- ▶ processor-independent Watchdog Timer
- ▶ Power Button
- ▶ 1x programmable status LED
- ▶ Power supply 24 VDC $\pm 20\%$, on 3-pin. Phoenix connector
- ▶ DIN rail mounting vertical (book form)

2.1. Dimensions and weight

External dimensions: W \ H \ D: 36.2 x 108 x 91 mm (without plug/rail clamps)

Weight: 385 g

2.2. Environmental conditions

List of permissible ambient conditions for the operation of the product.

Ambient temperature operation: 0 ... +55 °C

Ambient temperature storage: -20 ... +70 °C

Humidity: 10 - 90 % (non-condensing)

Pollution degree 2 acc. IEC 61010-1

Operating Altitude: max. 3000m above sea level

Atmosphere: free of corrosive or explosive gases

Protection class acc. IEC60529: IP20

EMC with correct wiring and shielding of the interfaces:

- ▶ according to EN 61000-6-2 Immunity (Industrial sector)
- ▶ according to EN 61000-6-4 Emission (Industrial sector)

▲ WARNING

This device is intended exclusively for use in industrial environments. In domestic environments this device may cause radio interference. In this case the user must take appropriate measures.

⚠ DANGER

No use in potentially explosive areas!

Use in hazardous areas can result in death, serious injury or considerable damage to property.

The device is not designed for use in hazardous areas and does not have the appropriate approvals.

2.3. Power supply

Supply voltage: +24 VDC \pm 20 %

Current consumption: 0.15 A – 1 A

Power consumption¹: 3.6 W – 24 W

Internal fusing: 2A melting fuse

External fusing with max.40A fuse required

On primary side overvoltage category II max. 300V

Recommended design of the power supply unit: Voltage/ output power: 24 VDC / min. 30 W

⚠ WARNING

The output of the power supply unit must meet the criteria of a safety extra-low voltage (SELV) according to IEC 60664-1.

The use of an unsuitable power supply unit can result in danger of electric shock.

⚠ CAUTION

The power cable must be rated for a temperature of +75° C or higher.

The cable can become damaged over time or potentially harmful plasticizers could be released in the surrounding air if cables with a lower temperature rating are being used.



The power consumption depends on the configuration as well as the type and number of active interfaces.



The internal fuse is not replaceable. Defective fuses must be replaced by qualified Kontron service.



USB devices connected to USB 2.0 interfaces may consume a maximum of 0.5A per interface.

¹depending on processor load and interface activity

2.4. Materials

The following materials are used for the housing of the Control Unit:

Housing: stainless steel

Heat sink: aluminium



This product complies with the RoHS Directive 2011/65/EU and the Delegate Directive (EU) 2015/863 amending Annex II of Directive 2011/65/EU (RoHS 3)



With regard to the REACH regulation or conflict minerals, please refer to the information on our website at:

<https://www.kontron.de/ueber-uns/corporate-responsibility/material-declaration/reach-customer-information>

2.5. Type Label and Product Identification

The type plate is located on the bottom opposite the heat sink of the Control Unit.

Figure 1: Type Label

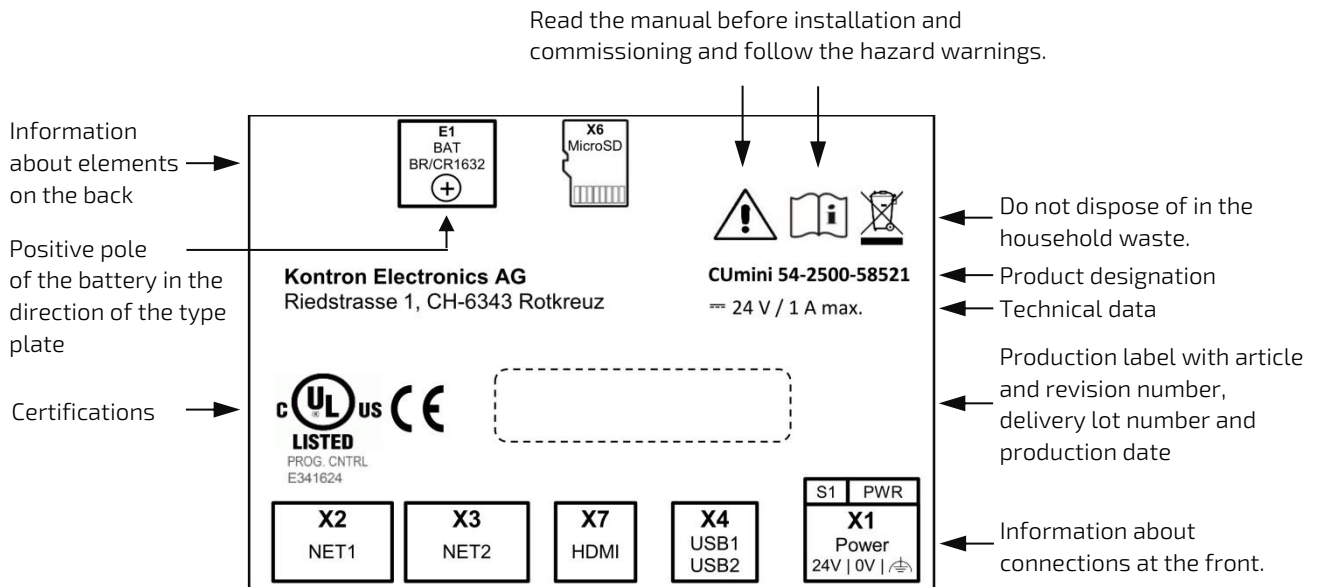

2.6. Accessories

Table 3: Zubehör for the Control Unit

Article No.	Designation	Comment
90211	Handbuch Control Unit CUmini 5x-2x0x	Deutsches Handbuch
90196	System Manual Linux	Deutsches Handbuch
90212	User Guide Control Unit CUmini 5x-2x0x	English User Manual
90208	System Manual Linux	English User Manual

3/ Design and function

3.1. Description of function

3.1.1. Processor

Depending on the version, the Control Unit is equipped with one of the following Intel® Atom™ processors:

Table 4: Possible processors

Designation	Cache	Clock frequency	Number of cores
Intel® Atom™ Prozessor E3815	1MB	1.46GHz	1 (Single Core)
Intel® Atom™ Prozessor E3825	1MB	1.33GHz	2 (Dual Core)
Intel® Atom™ Prozessor E3845	2MB	1.91GHz	4 (Quad Core)

3.1.2. BIOS

The BIOS controls the following functionalities among others:

- ▶ Phoenix Technologies SecureCore Technology for the E38xx platform
- ▶ UEFI BIOS for 32- and 64-Bit Operating systems
- ▶ UEFI/Legacy Boot Option
- ▶ Booting from USB, LAN, SD and eMMC
- ▶ Virtualization (Intel VT-x)
- ▶ Built-in UEFI Shell
- ▶ BIOS Password
- ▶ Execute Disable (XD)
- ▶ USB Support
- ▶ Fast Boot

3.1.3. NOR-Flash

The NOR flash memory installed on the Control Unit serves as BIOS memory. Its storage capacity is 64Mb.

3.1.4. DDR3L RAM

DDR3L-RAM is used as working memory.

The CPU module provides a SO-DIMM-204 slot. The total memory capacity is minimum 1GB up to maximum 4GB for single-core processors and maximum 8GB for multi-core processors. The assembly is done in the factory.

3.1.5. microSD

The microSD card slot X14 integrated on the base module allows the use of SD cards up to SDXC format. The 4-bit wide SDIO interface is routed directly from the processor to the microSD slot.

Supported UHS-I Modes: HS, DDR50, SDR12, SDR25

Modes: 1 bit, 4 bit

Maximum data rate: 400Mbit/s (in 4 bit Mode)

The microSD card must be inserted with the contacts facing the heat sink.

NOTICE

MicroSD cards available in consumer electronics stores are generally not designed or suitable for industrial applications. A lifetime in terms of write/erase cycles is often not specified for these cards and is in the range of a few hundred cycles.

When purchasing microSD cards, make sure that the card is suitable for the application and environmental conditions.

Unexpected data loss or device failure can result when using unsuitable microSD cards.

Kontron recommends microSD cards from [swissbit®](#).

3.1.6. eMMC

The bootable eMMC (JEDEC 5.0) built into the Control Unit serves as operating system and program memory. Depending on the version, the storage capacity is 4GB, 8GB, 16GB, 32GB, 64GB or 128GB.

3.1.7. SRAM / FRAM

The Control Unit can be equipped at the factory with SRAM up to 128kByte or FRAM up to 512kByte. The SRAM is supplied by the backup battery in case of power failure. FRAM do not require a power supply for data storage.

Under Windows operating system SRAM or FRAM is not supported.

3.1.8. Power Management and Power Button

The Power Button is located below the power connector X1 next to the PWR status LED.

The Control Unit supports the following power states of the Intel processor:

Table 5: Power Management Energy States (ACPI)

G/S State	Description	
G0/S0	FULL ON	CPU is running. Peripherals can be individually set to power save mode.
G1/S3	Suspend-to-RAM (STR) <i>Standby-Modus</i>	Most of the hardware is switched off, the operating status is stored in the volatile memory (RAM). The system can be woken up.
G1/S4	Suspend-to-Disk (STD) <i>Idle state</i>	The operating state is stored in non-volatile memory (boot medium). The system can be woken up.
G2/S5	Soft-Off	System is switched off (except RTC), but the supply voltage is present, therefore the system can be reactivated via the Power Button.
SoC G3	SoC Mechanical Off	System was switched off by power management. This can be necessary after system freeze and can be achieved by a long press (>4s) of the power button.

Table 6: Power Button Function

Initial state	Status after pressing the Power Button
G0/S0	G2/S5
G1/S3 or G1/S4	G2/S5
G2/S5 or SoC G3	G0/S0

The Power Button must be held down for at least 0.5s.

The function of the Power Buttons can be changed in the Control Panel under Windows (e.g. target state G1 instead of G2 from G0).

If the Power Button is held down for more than 4 seconds, the Control Unit goes into state SoC G3, independent of the configuration and processor state.



The setting in the BIOS under Advanced -> Miscellaneous Configuration -> "State after G3" has no effect due to the specific hardware of the control unit. From state G3 (disconnected from power supply) the device will always start automatically and go to state G0/S0.

3.1.9. Thermal Management

The internal processor temperature is used to throttle the clock rate and to shut down the operating system in case of overtemperature.

3.1.10. RTC

The RTC RX-8564LC from Seiko Epson is used as clock component. In combination with a backup battery, the time continues to run even in case of a power failure. The specified maximum deviation of the frequency corresponds approximately to the deviation of one minute per month. For correct operation, the appropriate driver from Kontron Electronics must be installed.

3.1.11. Watchdog

On the CPU module, the 32-bit binary counter DS1374 from Maxim is used as watchdog. For correct operation, the appropriate driver from Kontron Electronics must be installed.

3.1.12. Ethernet

Two Gigabit Ethernet interfaces are controlled via the PCIe interface of the CPU module. The WG1210 from Intel is used as Ethernet controller.

LEDs signal the respective interface status.

Table 7: Signaling Ethernet Interface status

LED orange (activity)	LED green (link1000)
off: no activity, no link	off: no link1000
blink: activity, link	on: link1000

3.2. Pin assignment

The Control Unit has the following connectors:

Table 8: Interfaces

Connector	Type	Purpose
X1	3-pole pluggable terminal pitch 5 mm for 24 VDC supply	Power
X2	RJ45 (8P8C) Connector for Ethernet	Ethernet
X3	RJ45 (8P8C) Connector for Ethernet	Ethernet
X4	2 port USB Host connector type A	USB 2.0
X6	microSD Card Slot	microSD
X7	HDMI, 19-pin for connector type C (mini)	HDMI

Figure 2: Interfaces/Connectors Front side

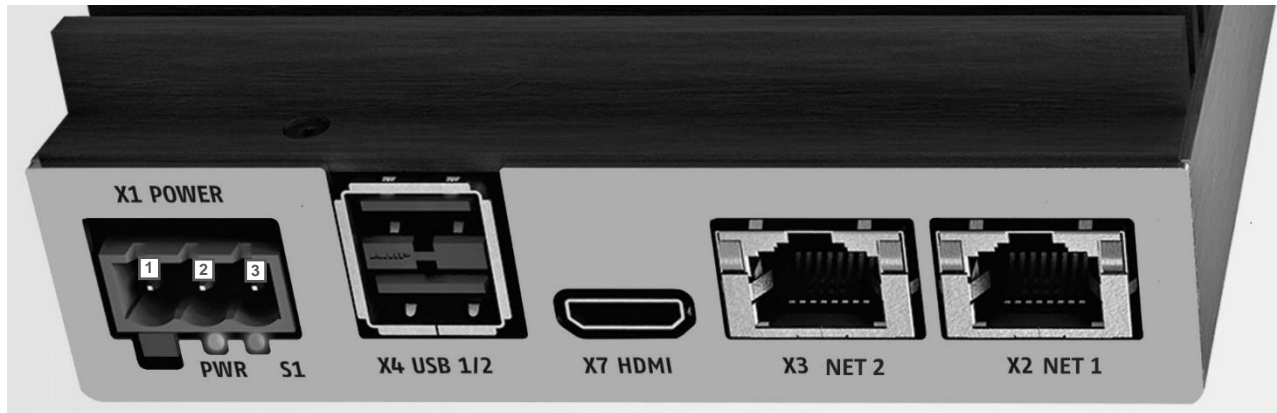
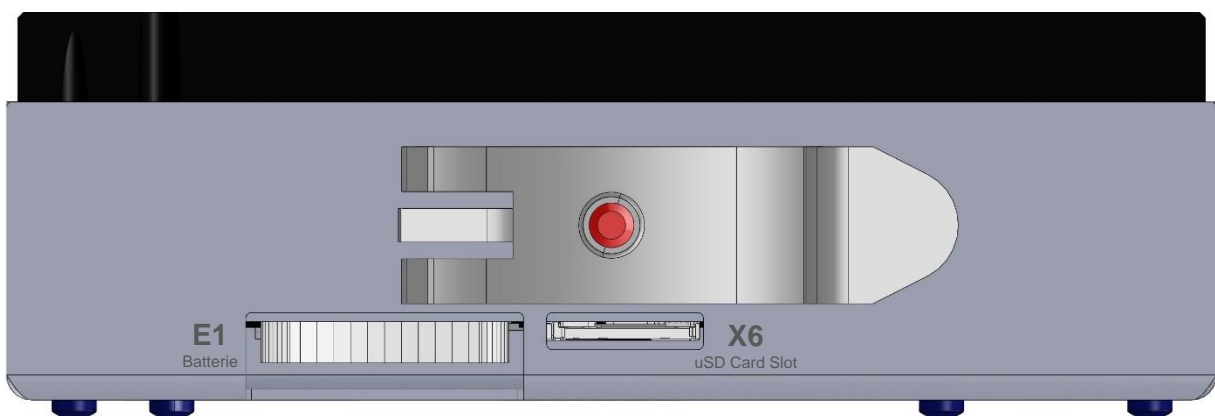

Figure 3: Interfaces/Connectors Back side



3.2.1. Status LEDs

There are two status LEDs next to the X1 Power connector.

Table 9: Status LEDs

Designation	Colour	Meaning
PWR	Green	Lights up permanently if 24V supply is available and the device is not in state SoC G3 (see chapter 3.1.8)
S1	Blue	Connected to GPIO of the processor. Can be controlled by user software. In delivery configuration it indicates an active system (not in state G2/S6 or SoC G3).

3.2.2. Power Button

The Power Button is located below the power connector X1 next to the PWR status LED. The function of the Power Button is described in chapter 3.1.8.

3.2.3. Power supply Connector X1

Table 10: Power supply Connector X1

Pin	Signal	Comment
1	FE	Functional earth
2	0V	Power supply 0 Volt DC
3	24V	Power supply +24 VDC ±20%

Cable (acc. to chapter 2.2/ EMC): max. 3 m, unshielded

Connector type: Phoenix MSTBA 2,5/3-G – 1757488

Mating connector: Phoenix FKCN 2.5/ 3-ST-5.08-- 1873061 (included in delivery)

Associated permissible cable cross-sections:

- ▶ rigid conductor cross-section: 0,2 mm² ... 1,5 mm²
- ▶ Flexible conductor cross-section: 0,2 mm² ... 2,5 mm²
- ▶ Conductor cross section AWG / kcmil: 24 ... 16
- ▶ Conductor cross-section flexible with wire end ferrule: 0,25 mm² ... 1,5 mm²
- ▶ Stripping length: 10 mm

CAUTION

The power cable must be rated for a temperature of +75° C or higher.

The cable can become damaged over time or potentially harmful plasticizers could be released in the surrounding air if cables with a lower temperature rating are being used.



In Europe, the flatter type Phoenix FKCN 2.5/ 3-ST - 1732755 can also be used as a mating connector for X1. However, this type is not permitted in the USA and Canada, since only the Phoenix FKCN 2.5/ 3-ST-5.08 - 1873061 has the UL registration required for this region

3.2.4. Ethernet connector X2 and X3

Table 11: Ethernet connector X2 and X3

Pin	Signal	Comment
1	DA+	TX
2	DA-	TX
3	DB+	RX
4	DC+	BI
5	DC-	BI
6	DB-	RX
7	DD+	BI
8	DD-	BI

Cable (according to chapter 2.2/ EMC): smaller 30 m, shielded, min. Cat-5e

3.2.5. HDMI connector X7

The device has a type C HDMI socket (HDMI mini). The DDC data bus is available, CEC is not available.

⚠ WARNING

Use a high quality HDMI cable which is double shielded with a cable length of less than 3m. Otherwise, compliance with the applicable EMC standards cannot be guaranteed. Kontron recommends the use of a certified "Premium High Speed HDMI" cable with the appropriate label from HDMI Licensing Administrator Inc.

NOTICE

Kontron is HDMI Adopter (Version 1.4) and pays the corresponding license fees to HDMI Licensing Administrator Inc. HDCP (High-bandwidth Digital Content Protection) is not supported.

3.2.6. USB 2.0 Host: connector X4

The pin assignment corresponds to the USB 2.0 standard, connector type A. The connected USB cable must be shielded and have a cable length of less than 3m.

4/ Assembly and installation

Prior to commissioning, the temperature of the unit must be adjusted to the room temperature.

▲WARNING

Observance of the standards and regulations of the country of destination
Improper installation may result in death, serious injury or serious damage to property.
The device must be installed in machines or systems in compliance with all standards and regulations applicable in the countries of destination and may only be installed by a trained specialist who is familiar with the respective regulations.

▲WARNING

Malfunctions due to improper earthing of the device.
The device must be properly grounded.
Compliance with the prescribed EMC limit values can only be guaranteed if the device is properly grounded.

NOTICE

Damage to plugs or cables due to improper handling when plugging in and plugging out
Material damage to cables, plugs and other plant components can result.
Always hold the plug when plugging and unplugging a cable.

NOTICE

Observe correct installation position
The device is exclusively intended for operation when mounted on the top hat rail in book form in accordance with the installation instructions in chapter 4.1. The prescribed minimum distances to other devices mounted on the top hat rail must be observed. If the device is not mounted according to the instructions, heat dissipation cannot be guaranteed and the device will overheat. This in turn can result in a loss of performance or an unexpected shutdown of the device.

4.1. DIN rail mounting

Mounting or dismounting on the DIN rail is done as described in Figure 4. A minimum distance of 10 cm must be maintained to other devices or objects on the DIN rail on both sides. If necessary, the distance must be increased if the installation regulations of the neighboring device require a greater distance.

Figure 4: Mounting and dismounting a Control Unit on a DIN rail

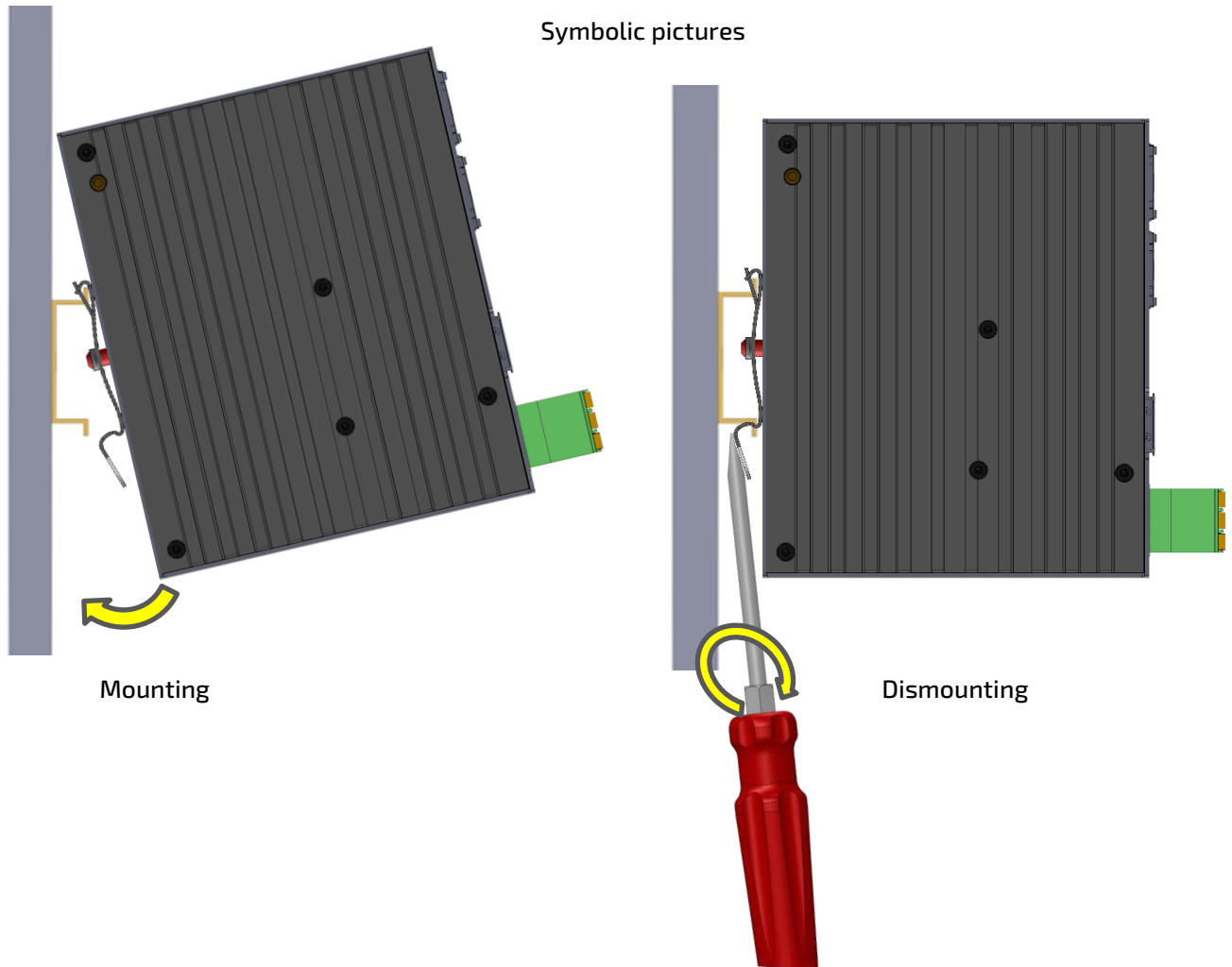

5/ Commissioning

5.1. Power supply

The device is operated with 24 VDC. The power supply must be connected to connector X1. For connector assignment and conductor cross-sections, see chapter 3.2.3.

For power consumption and supply requirements see Chapter 2.3.

5.2. Grounding

The device must be grounded via the functional earth connection of the power supply connector X1 with sufficiently low impedance (< 1 Ohm) to avoid possible transmitted interference from signal cables or external assemblies. Recommended cable cross-section is 1.5 mm².

5.3. Operating system

Depending on the version, one of the following operating systems is preinstalled on the Control Unit.

5.3.1. Microsoft Windows 10 IoT Enterprise

Windows 10 IoT Enterprise contains (almost) all features that are also included in Windows 10 Pro. Not included functions are the Microsoft Store and the Edge Browser.

Windows 10 IoT Enterprise is subject to the so-called LTSC (Long Term Servicing Channel). This means that functional upgrades are only provided every two to three years and can be installed manually. However, security updates and patches are installed automatically at the same time. In this way, Microsoft guarantees the secure use of its operating system for industrial customers, without them being confronted with compatibility problems as in the past.

5.3.2. Linux

Any Linux distribution for the x86 architecture can be installed on the Control Unit.

The development environment is based on the well-known open source tools like Eclipse, Qt Creator, GNU toolchain. We deliver devices with Linux as standard with Linux Debian and our comfortable system configuration menu. In addition, our fast HTML5 browser tailored to industrial users and the CODESYS soft PLC packages are also available.

5.4. System configuration with Linux Debian

The system configuration feature provides an easy to use interface for setting up the device (only implemented for versions with Linux Debian). This can be selected locally on the device at startup in a selection menu of the integrated web browser or called via a web browser on another device that is connected to the device via Ethernet.

The clear menu structure makes it possible to quickly find the numerous setting options such as network settings, URL, CODESYS, display, FTP, IP-Tables, screensaver, web browser settings, passwords, diagnostics, etc.

Default IP addresses for panel access:

Ethernet 1: 192.168.1.100 (Subnet: 255.255.255.0)

Ethernet 2: 192.168.1.101 (Subnet: 255.255.255.0)

Default passwords (factory setting):

- ▶ User: root
- ▶ Password: root

A detailed description of the settings and functions can be found in the System Manual Linux. See Chapter 2.6/ Accessories.

The System Manual is also integrated in the system configuration of the device.

5.5. HTML5 Browser with Linux Debian

The Chromium based HTML5 browser allows the display of web pages or a CODESYS V3 WebVisu. The URL and the device IP address are set via the system configuration, via an own web server on an external web browser or via a script file on a connected USB stick.

5.6. Soft-PLC CODESYS with Linux Debian

The optionally integrated Soft-PLC CODESYS from CODESYS GmbH allows convenient PLC program generation according to IEC 61131-3. Various industrial protocols and the integration of C/C++ code are supported. The interfaces available to the user are documented in the manual for the development environment. The development environment can be requested free of charge from Kontron Electronics AG at support@kontron.ch.

The device supports CODESYS V3.

The CODESYS Device Package contains all device descriptions and libraries for the CODESYS development environment. The CODESYS Device Package can be ordered free of charge from Kontron Electronics AG at support@kontron.ch. The CODESYS PLC application is loaded into the Flash-memory of the processor board via the microSD card, USB or Ethernet interface.

If the device was purchased with the CODESYS PLC license, the corresponding runtime license is delivered together with the hardware.

5.7. CODESYS Visualizations with Linux Debian

The optionally integrated development environment CODESYS from 3S allows the efficient creation of graphical user interfaces with or without touch screen. The visualization variants TargetVisu, WebVisu and HMI-Remote are supported. The interfaces that are available to the user are documented in the manual for the development environment. The development environment can be requested free of charge from Kontron Electronics AG at support@kontron.ch

The CODESYS Visu application is loaded into the flash memory of the CPU module via the microSD card, USB or Ethernet interface. The devices IP and CODESYS settings are made via the system configuration.

Depending on the acquired CODESYS HMI functional scope (CODESYS Target- and/or WebVisu) the corresponding licenses are delivered together with the hardware.

5.8. Backup/Restore the system (Live System)

The Backup/Restore function (Live System) allows easy backup and restore of the complete device via USB stick or SD card.

With a backup of the system, the devices can be reset to a defined state or even cloned.

The backup/restore function is integrated in the system configuration and can be accessed directly via the selection menu.

For other operating systems, the live system for the backup/restore function can be requested from Kontron Electronics AG via support@kontron.ch

6/ Maintenance

There is no maintenance interval prescribed by the manufacturer of the product.

6.1. Battery replacement

A battery of the type CR1632 or BR1632(A) is used as backup battery for the RTC and if available also SRAM.

To replace the battery, pull out the side tab of the battery holder E1 on the device and replace the battery with a new one. The battery holder is then plugged back into the device.

When replacing the battery, make sure that the battery and the battery holder are inserted with the correct orientation as shown in the illustrations below.

Figure 5: Battery replacement

<p>Pull out the tab of the battery holder and thus the whole battery holder out of the device. Remove the old battery from the holder.</p>	
<p>Insert the battery into the holder with the positive pole facing upwards</p>	
<p>Slide the battery holder with the open side towards the bottom (type plate)</p>	

NOTICE

Insert the battery correctly into the battery holder.

If the battery is inserted with the wrong side, the non-volatile data and real time clock of the device will not be buffered if the supply voltage fails.

The battery must be inserted into the battery holder with the positive pole upwards and the battery holder must be inserted with the open side towards the bottom of the device (type plate).

⚠ WARNING

Only use batteries of the specified type which are in conformity to the EU Directives 2006/66/EC and 2013/56/EU (Battery Directive) and Regulation (EC) No. 1907/2006 (REACH) and observe the safety instructions of the battery manufacturer.

Batteries contain toxic substances which, if used improperly, can lead to chemical burns and material damage.

Only use 3V lithium batteries type CR1632 or BR1632(A) as replacement batteries which comply with the EU Directives 2013/56/EU (Battery Directive) and Regulation (EC) No. 1907/2006 (REACH). Recommended by Kontron Electronics AG are Renata, Varta and Panasonic. Batteries must not be disposed of with household waste and must not be incinerated. Observe the disposal regulations applicable at your location.

Batteries must always be kept out of the reach of children as there is a health hazard if swallowed.

6.2. Cleaning

The device can be cleaned as required. There is no cleaning interval prescribed by the manufacturer of the product.

NOTICE

Penetration of liquids during cleaning

Damage to property or destruction of the device may result.

If necessary, the device can be cleaned with a dry cloth. When cleaning the device, make sure that no liquids get inside.

7/ Malfunctions

Table 12: Malfunctions

Malfunction	Possible cause	Recommended action
No function	No or incorrect power supply to the device	Check if the wiring at X1 is correct. Measure supply voltage.
No image over HDMI	Settings in BIOS are not correct	Contact the support
Interface function impaired	Interface cable not plugged in correctly	Check whether all interface cables are plugged in correctly and the pin assignment is correct.

NOTICE

Loss of warranty due to manipulation of the device

Repairs and other manipulations of the device may only be carried out by the manufacturer. In particular, opening the device is prohibited. Otherwise any warranty will become void.

8/ Decommissioning and disposal

NOTICE

Disposal of electrical material and batteries

Electrical appliances and batteries must be disposed of in accordance with local regulations. If necessary, contact your local waste disposal company for information. Do not throw devices into the household waste and do not burn them.

Remove the backup battery from the device and dispose of it separately.

Kontron will gladly take back old electrical equipment at the end of its service life for proper disposal. Due to international transport regulations, the battery must be removed before return shipment and disposed of separately.

It is recommended that the positive and negative terminals of the battery be taped with a piece of insulating tape before disposal to prevent short circuits in the collection container.

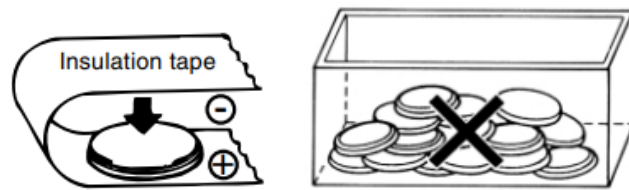

9/ Technical drawings

9.1. Views and dimensions

Figure 6: Views and dimensions

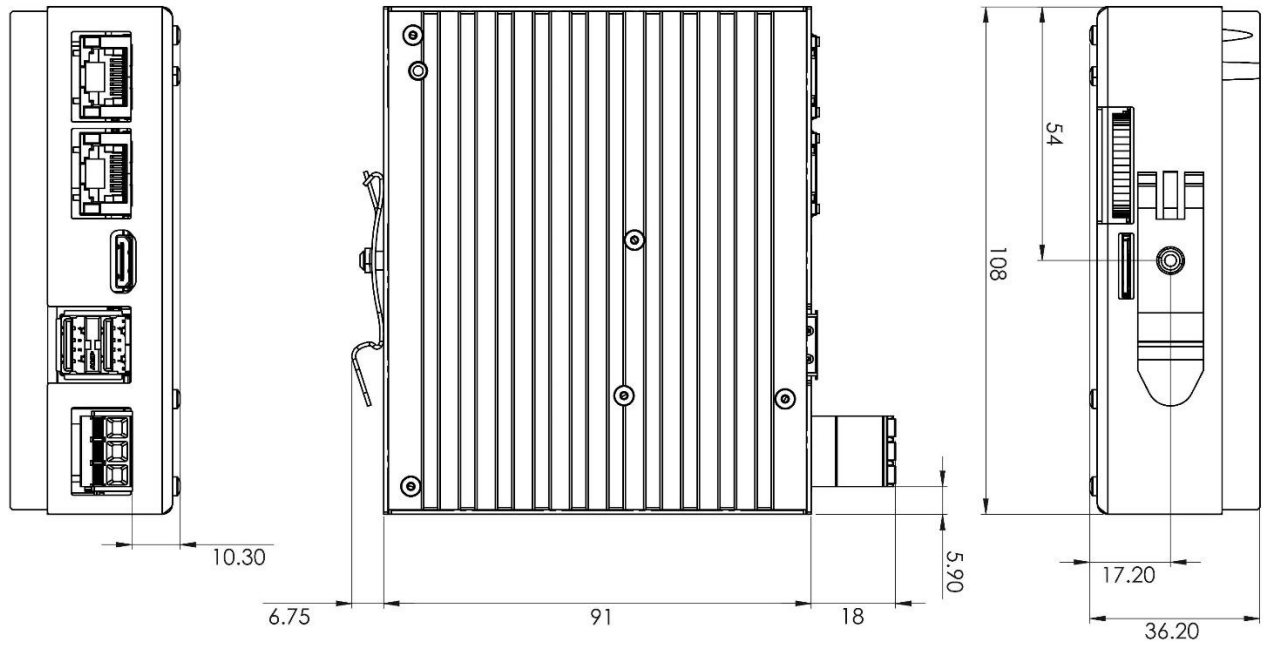

10/ Technical Support

For technical support contact our Support department:

- ▶ Email: support@kontron.com
- ▶ Phone: +49-821-4086-888

Make sure you have the following information available when you call:

- ▶ Article number or product ID number (PN),
- ▶ Production batch or Serial Number (SN)



The numbers are located on a small label on the nameplate.

Be ready to explain the nature of your problem to the service technician.

10.1. Warranty

Due to their limited service life, parts that by their nature are subject to a particularly high degree of wear (wearing parts) are excluded from the warranty beyond that provided by law. This applies to the backup battery, for example.

10.2. Returning Defective Merchandise

All equipment returned to Kontron must have a Return of Material Authorization (RMA) number assigned exclusively by Kontron. Kontron cannot be held responsible for any loss or damage caused to the equipment received without an RMA number. The buyer accepts responsibility for all freight charges for the return of goods to Kontron's designated facility. Kontron will pay the return freight charges back to the buyer's location in the event that the equipment is repaired or replaced within the stipulated warranty period. Follow these steps before returning any product to Kontron.

1. Visit the RMA Information website:

<http://www.kontron.com/support-and-services/support/rma-information>

Download the RMA Request sheet for **Kontron Europe GmbH** and fill out the form. Take care to include a short detailed description of the observed problem or failure and to include the product identification Information (Name of product, Product number and Production batch or Serial number). If a delivery includes more than one product, fill out the above information in the RMA Request form for each product.

2. Send the completed RMA-Request form to the fax or email address given below at Kontron Europe GmbH. Kontron will provide an RMA-Number.

Kontron Europe GmbH
RMA Support
Phone: +49 (0) 821 4086-0
Fax: +49 (0) 821 4086 111
Email: service@kontron.com

3. The goods for repair must be packed properly for shipping, considering shock and ESD protection.



Goods returned to Kontron Europe GmbH in non-proper packaging will be considered as customer caused faults and cannot be accepted as warranty repairs.

4. Include the RMA-Number with the shipping paperwork and send the product to the delivery address provided in the RMA form or received from Kontron RMA Support.

Appendix A: List of Acronyms

Table 13: List of used Acronyms

CU	Control Unit
eMMC	embedded Multimedia Card
EMC	Electromagnetic compatibility; interference immunity to electrical or electromagnetic influences
ESD	Electrostatic Discharge; ; electrostatic discharge, high electrical voltage pulse
HDMI	High Definition Multimedia Interface; Interface for digital image & sound transmission in consumer electronics - subject to licence
HMI	Human Machine Interface; Interface between machine and user
I/O	Input/Output
RTC	Real Time Clock
SELV	Safety Extra Low Voltage
Soft-PLC	Programmable logic controller in Software
UEFI	Unified Extensible Firmware Interface
WDT	Watchdog Timer

Appendix B: Product Configurations

CUmini 5x-2x0x-xxxxx

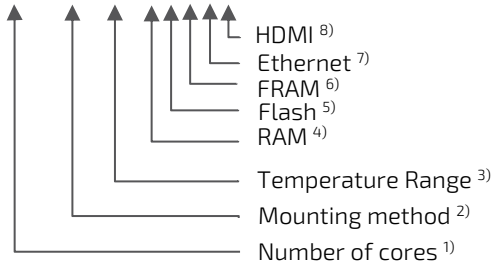

¹⁾ Number of cores	X =
Single Core Prozessor	1
Dual Core Prozessor	2
Quad Core Prozessor	4

²⁾ Mounting method	X =
DIN rail upright (book form)	5

³⁾ Temperature Range	X =
Standard (0 °C ... +55 °C)	0

⁴⁾ RAM	X =
2GB	4
4GB	5

⁵⁾ Flash	X =
16GB eMMC	7
32GB eMMC	8
64GB eMMC	9

⁶⁾ FRAM	X =
64kB	4
128kB	5
256kB	6
512kB	7

⁷⁾ Ethernet	X =
0 Ports	0
1 Port	1
2 Ports	2

⁸⁾ HDMI	X =
Not available	0
1 Port HDMI mini	1

This page has been intentionally left blank.

This page has been intentionally left blank.

This page has been intentionally left blank.



About Kontron

Kontron is a global leader in Embedded Computing Technology (ECT). As a part of technology group S&T, Kontron offers a combined portfolio of secure hardware, middleware and services for Internet of Things (IoT) and Industry 4.0 applications. With its standard products and tailor-made solutions based on highly reliable state-of-the-art embedded technologies, Kontron provides secure and innovative applications for a variety of industries. As a result, customers benefit from accelerated time-to-market, reduced total cost of ownership, product longevity and the best fully integrated applications overall. For more information, please visit: www.kontron.com

▼

Your Contact

Kontron Electronics AG

Riedstrasse 1
6343 Rotkreuz
Switzerland
Tel.: + 41 41 799 47 99
Fax: + 41 41 799 47 98
info@kontron.ch

Global Headquarters

Kontron S&T AG

Lise-Meitner-Str. 3-5
86156 Augsburg
Germany
Tel.: + 49 821 4086-0
Fax: + 49 821 4086-111
info@kontron.com