

COMe-bRP6 (E2)

User Guide Rev. 1.0

kontron

Table of Contents

1. General Information	1
1.1 Disclaimer	1
1.2 Intended Use	2
1.3 Terms and Conditions	3
1.4 Customer Support	3
1.5 Customer Service	3
1.6 Customer Comments	3
1.7 Symbols	4
1.8 For Your Safety	5
1.9 High Voltage Safety Instructions	5
1.10 Special Handling and Unpacking Instruction	5
1.11 Lithium Battery Precautions	6
1.12 General Instructions on Usage	6
1.13 Quality and Environmental Management	7
1.13.1 Disposal and Recycling	7
1.13.2 WEEE Compliance	7
2. Introduction	8
2.1 Product Naming Clarification	8
2.2 Product Description	8
2.3 COM Express® Documentation	9
2.4 COM Express® Functionality	9
2.5 COM Express® Benefits	10
3. Product Specification	11
3.1 Module Variants	11
3.1.1 Commercial Grade Modules (0°C to +60°C)	11
3.1.2 Extended Temperature Grade Modules (E1, -25°C to +75°C)	11
3.1.3 Industrial Temperature Grade Modules (E2, -40°C to +85°C)	12
3.2 Accessories	13
3.3 Functional Specification	14
3.3.1 Technical Data	14
3.3.2 Block Diagram	15
3.3.3 Front View	16
3.3.4 Rear View	17
3.3.5 Processor (CPU)	18
3.3.6 Platform Controller Hub (PCH)	19
3.3.7 System Memory	20
3.3.8 High-Speed Interface Overview	21
3.4 Interfaces	22
3.4.1 PCI Express	22
3.4.2 Universal Serial Bus (USB)	24
3.4.3 Serial ATA (SATA)	24
3.4.4 Ethernet	25
3.4.5 Graphics Interfaces	25
3.4.6 Audio Interfaces	26
3.4.7 UART Serial Ports	27
3.4.8 General Purpose SPI interface	28
3.4.9 Boot SPI	28
3.4.10 LPC/eSPI	29

3.4.11 I2C	30
3.4.12 General Purpose IOs (GPIOs)	31
3.4.13 SMBus	31
3.5 Features	32
3.5.1 ACPI Power States	32
3.5.2 Embedded Controller - Hardware Monitor	33
3.5.3 Trusted Platform Module (TPM)	33
3.5.4 Watchdog Timer (WDT)	34
3.5.5 Real-Time Clock (RTC)	35
3.5.6 NVMe	35
3.5.7 Boot SPI Device	36
3.5.8 Embedded EEPROM	37
3.6 Electrical Specification	38
3.6.1 Power Supply Specification	38
3.6.2 Power Management	39
3.6.3 Power Supply Modes	41
3.7 Thermal Management	43
3.7.1 Heatspreader Plate Assembly	43
3.7.2 Active/Passive Cooling Solutions	43
3.7.3 Operating with Kontron Heatspreader Plate (HSP) Assembly	43
3.7.4 Operating without Kontron Heatspreader Plate (HSP) Assembly	44
3.7.5 Temperature Sensors	45
3.7.6 On-Module Fan Connector	47
3.8 Mechanical Specification	49
3.8.1 Module Dimensions	49
3.8.2 Module Height	50
3.8.3 Heatspreader Plate Assembly Dimensions	50
3.9 Environmental Specification	51
3.10 Compliance	52
3.11 MTBF	54
4. COMe Interface Connector	55
4.1 Connecting COMe Interface Connector to Carrier Board	55
4.2 J1 and J2 Signals	56
4.3 Connector J1 Pinout	57
4.3.1 Pins A1 - A110	57
4.3.2 Pins B1 - B110	62
4.4 Connector J2 Pinout	67
4.4.1 Pins C1 - C110	67
4.4.2 Pins D1 - D110	73
5. UEFI BIOS	79
5.1 Starting the UEFI BIOS	79
5.2 Navigating the UEFI BIOS	80
5.3 Setup Menus	80
5.4 Getting Help	81
5.5 UEFI Shell	82
5.5.1 Entering the UEFI Shell	82
5.5.2 Exiting the UEFI Shell	82
5.6 UEFI Shell Scripting	83
5.6.1 Startup Scripting	83
5.6.2 Create a Startup Script	83
5.6.3 Example of Startup Scripts	83

5.7 Firmware Update	83
6. Technical Support	84
6.1 Warranty	84
6.2 Returning Defective Material	84
7. Document Revision	86

1. General Information

1.1 Disclaimer

Kontron would like to point out that the information contained in this user guide may be subject to alteration, particularly as a result of the constant upgrading of Kontron products. This document does not entail any guarantee on the part of Kontron with respect to technical processes described in the user guide or any product characteristics set out in the user guide. Kontron assumes no responsibility or liability for the use of the described product(s), conveys no license or title under any patent, copyright or mask work rights to these products and makes no representations or warranties that these products are free from patent, copyright or mask work right infringement unless otherwise specified. Applications that are described in this user guide are for illustration purposes only. Kontron makes no representation or warranty that such application will be suitable for the specified use without further testing or modification. Kontron expressly informs the user that this user guide only contains a general description of processes and instructions which may not be applicable in every individual case. In cases of doubt, please contact Kontron.

This user guide is protected by copyright. All rights are reserved by Kontron. No part of this document may be reproduced, transmitted, transcribed, stored in a retrieval system, or translated into any language or computer language, in any form or by any means (electronic, mechanical, photocopying, recording, or otherwise), without the express written permission of Kontron. Kontron points out that the information contained in this user guide is constantly being updated in line with the technical alterations and improvements made by Kontron to the products and thus this user guide only reflects the technical status of the products by Kontron at the time of publishing.

Brand and product names are trademarks or registered trademarks of their respective owners.

©2024 by Kontron Europe GmbH

Kontron Europe GmbH
Gutenbergstraße 2
85737 Ismaning
Germany
www.kontron.com

1.2 Intended Use

THIS DEVICE AND ASSOCIATED SOFTWARE ARE NOT DESIGNED, MANUFACTURED OR INTENDED FOR USE OR RESALE FOR THE OPERATION OF NUCLEAR FACILITIES, THE NAVIGATION, CONTROL OR COMMUNICATION SYSTEMS FOR AIRCRAFT OR OTHER TRANSPORTATION, AIR TRAFFIC CONTROL, LIFE SUPPORT OR LIFE SUSTAINING APPLICATIONS, WEAPONS SYSTEMS, OR ANY OTHER APPLICATION IN A HAZARDOUS ENVIRONMENT, OR REQUIRING FAIL-SAFE PERFORMANCE, OR IN WHICH THE FAILURE OF PRODUCTS COULD LEAD DIRECTLY TO DEATH, PERSONAL INJURY, OR SEVERE PHYSICAL OR ENVIRONMENTAL DAMAGE (COLLECTIVELY, “HIGH RISK APPLICATIONS”).

You understand and agree that your use of Kontron devices as a component in High Risk Applications is entirely at your risk. To minimize the risks associated with your products and applications, you should provide adequate design and operating safeguards. You are solely responsible for compliance with all legal, regulatory, safety, and security related requirements concerning your products. You are responsible to ensure that your systems (and any Kontron hardware or software components incorporated in your systems) meet all applicable requirements. Unless otherwise stated in the product documentation, the Kontron device is not provided with error-tolerance capabilities and cannot therefore be deemed as being engineered, manufactured or setup to be compliant for implementation or for resale as device in High Risk Applications. All application and safety related information in this document (including application descriptions, suggested safety measures, suggested Kontron products, and other materials) is provided for reference only.



Handling and operation of the product is permitted only for trained personnel within a work place that is access controlled. Follow the “General Safety Instructions” supplied with the product.



You find the most recent version of the “General Safety Instructions” online in the download area of this product in our [Customer Section](#).



This product is not suited for storage or operation in corrosive environments, in particular under exposure to sulfur and chlorine and their compounds. For information on how to harden electronics and mechanics against these stress conditions, contact Kontron Support.

1.3 Terms and Conditions

Kontron warrants products in accordance with defined regional warranty periods. For more information about warranty compliance and conformity, and the warranty period in your region, visit <https://www.kontron.com/terms-and-conditions>.

Kontron sells products worldwide and declares regional General Terms & Conditions of Sale, and Purchase Order Terms & Conditions. Visit <https://www.kontron.com/terms-and-conditions>.

For contact information, refer to the corporate offices contact information on the last page of this user guide or visit our website [CONTACT US](#).

1.4 Customer Support

Find Kontron contacts by visiting: <https://www.kontron.com/en/support-and-services>.

1.5 Customer Service

As a trusted technology innovator and global solutions provider, Kontron extends its embedded market strengths into a services portfolio allowing companies to break the barriers of traditional product lifecycles. Proven product expertise coupled with collaborative and highly-experienced support enables Kontron to provide exceptional peace of mind to build and maintain successful products. For more details on Kontron's service offerings such as: enhanced repair services, extended warranty, Kontron training academy, and more visit <https://www.kontron.com/en/support-and-services>.

1.6 Customer Comments

If you have any difficulties using this user guide, discover an error, or just want to provide some feedback, contact [Kontron Support](#). Detail any errors you find. We will correct the errors or problems as soon as possible and post the revised user guide on our website.

1.7 Symbols

The following symbols may be used in this user guide of COMe-bRP6

simple Box



Info-Box



Important-Box



Alert-Box



Tip-Box



Help-Box



Todo-Box



Download-Box

1.8 For Your Safety

Your new Kontron product was developed and tested carefully to provide all features necessary to ensure its compliance with electrical safety requirements. It was also designed for a long fault-free life. However, the life expectancy of your product can be drastically reduced by improper treatment during unpacking and installation. Therefore, in the interest of your own safety and of the correct operation of your new Kontron product, you are requested to conform with the following guidelines.

1.9 High Voltage Safety Instructions

As a precaution and in case of danger, the power connector must be easily accessible. The power connector is the product's main disconnect device.



Warning

All operations on this product must be carried out by sufficiently skilled personnel only.



Electric Shock!

Before installing a non hot-swappable Kontron product into a system always ensure that your mains power is switched off. This also applies to the installation of piggybacks. Serious electrical shock hazards can exist during all installation, repair, and maintenance operations on this product. Therefore, always unplug the power cable and any other cables which provide external voltages before performing any work on this product. Earth ground connection to vehicle's chassis or a central grounding point shall remain connected. The earth ground cable shall be the last cable to be disconnected or the first cable to be connected when performing installation or removal procedures on this product.

1.10 Special Handling and Unpacking Instruction



ESD Sensitive Device!

Electronic boards and their components are sensitive to static electricity. Therefore, care must be taken during all handling operations and inspections of this product, in order to ensure product integrity at all times.

Do not handle this product out of its protective enclosure while it is not used for operational purposes unless it is otherwise protected.

Whenever possible, unpack or pack this product only at EOS/ESD safe work stations. Where a safe work station is not guaranteed, it is important for the user to be electrically discharged before touching the product with his/her hands or tools. This is most easily done by touching a metal part of your system housing.

It is particularly important to observe standard anti-static precautions when changing piggybacks, ROM devices, jumper settings etc. If the product contains batteries for RTC or memory backup, ensure that the product is not placed on conductive surfaces, including anti-static plastics or sponges. They can cause short circuits and damage the batteries or conductive circuits on the product.

1.11 Lithium Battery Precautions

If your product is equipped with a lithium battery, take the following precautions when replacing the battery.



Danger of explosion if the battery is replaced incorrectly.

- Replace only with same or equivalent battery type recommended by the manufacturer.
- Dispose of used batteries according to the manufacturer's instructions.

1.12 General Instructions on Usage

In order to maintain Kontron's product warranty, this product must not be altered or modified in any way. Changes or modifications to the product, that are not explicitly approved by Kontron and described in this user guide or received from Kontron Support as a special handling instruction, will void your warranty.

This product should only be installed in or connected to systems that fulfill all necessary technical and specific environmental requirements. This also applies to the operational temperature range of the specific board version that must not be exceeded. If batteries are present, their temperature restrictions must be taken into account. In performing all necessary installation and application operations, only follow the instructions supplied by the present user guide.

Keep all the original packaging material for future storage or warranty shipments. If it is necessary to store or ship the product, then re-pack it in the same manner as it was delivered. Special care is necessary when handling or unpacking the product. See Special Handling and Unpacking Instruction.

1.13 Quality and Environmental Management

Kontron aims to deliver reliable high-end products designed and built for quality, and aims to complying with environmental laws, regulations, and other environmentally oriented requirements. For more information regarding Kontron's quality and environmental responsibilities, visit <https://www.kontron.com/en/quality-management>.

1.13.1 Disposal and Recycling

Kontron's products are manufactured to satisfy environmental protection requirements where possible. Many of the components used are capable of being recycled. Final disposal of this product after its service life must be accomplished in accordance with applicable country, state, or local laws or regulations.

1.13.2 WEEE Compliance

The Waste Electrical and Electronic Equipment (WEEE) Directive aims to:

- Reduce waste arising from electrical and electronic equipment (EEE)
- Make producers of EEE responsible for the environmental impact of their products, especially when the product become waste
- Encourage separate collection and subsequent treatment, reuse, recovery, recycling and sound environmental disposal of EEE
- Improve the environmental performance of all those involved during the lifecycle of EEE

Environmental protection is a high priority with Kontron.

Kontron follows the WEEE directive.

You are encouraged to return our products for proper disposal.

2. Introduction

This user guide describes the COM Express® Type 6 Basic Computer-On-Module COMe-bRP6 made by Kontron and focuses on describing the module's special features. Kontron recommends users to study this user guide before powering on the module.

2.1 Product Naming Clarification

COM Express® defines a Computer-On-Module (COM), with all the components necessary for a bootable host computer, packaged as a super component. The product name for Kontron COM Express® Computer-On-Modules consists of:

Standard short form	Module form factor	Processor family identifier	Pinout type	Available temperature variants
COMe-	b= basic (125mm x 95mm) c= compact (95mm x 95mm) m= mini (84mm x 55mm)	AP = Alder Lake P TL = Tiger Lake EL = Elkhart Lake etc.	10 = Type 10 7 = Type 7 6 = Type 6	Commercial (none) Extended (E1) Industrial (E2) Screened industrial (E2S)

Table 1: COM Express® Product Naming Clarification

2.2 Product Description

The COMe-bRP6 is a compact form factor COM Express® type 6 Computer-On-Module designed for flexible implementation within multiple embedded industrial environments. It is based on a 13th Gen Intel® Core™ processor supporting up to 14 cores and 20 threads with Intel® Hybrid technology. The COMe-bRP6 features an optimized power-performance ratio with a power consumption of 15 to 45 W TDP (Thermal Design Power). The module also comes with up to 64 GB of LPDDR5 soldered memory and up to 2.5 Gbit Ethernet. As storage medium, a NVMe SSD up to 1 TB can be optionally integrated onboard.

The COMe-bRP6 is ideally suited as a powerful successor for existing solutions, as it takes over their pin assignment and feature implementation. Typical applications include communication, digital signage, professional gaming and entertainment, medical imaging, surveillance and security, industrial edge computing as well as industrial plant-, machine- and robot-control at the shop floor level and from the control room.

Key features are:

- Up to 64 GB LPDDR5 memory down
- Up to 2.5 Gbit Ethernet with TSN support
- Optional NVMe SSD onboard
- Industrial grade versions

2.3 COM Express® Documentation

The COM Express® specification defines the COM Express® module form factor, pinout and signals. For more COM Express® specification information, visit the [PCI Industrial Computer Manufacturers Group \(PICMG®\)](#) website.

2.4 COM Express® Functionality

All Kontron COM Express® basic modules contain two 220-pin connectors, each of which has two rows called row A & B on the primary connector and row C & D on the secondary connector. The COM Express® basic type 6 Computer-On-Module features the following maximum amount of interfaces according to the PICMG module pinout type.

Feature	Type 6	COMe-bRP6
Gbit Ethernet	1x	1x up to 2.5GbE
PCI Express x1	8x	5x PCIe 3.0 (6x without Ethernet, up to 8x without Ethernet & SATA or alternatively 8x with additional PCIe Switch)
PCI Express x16 (PEG)	1x	2x4 PCIe 4.0 on PEG Lanes #0-7 1x8 PCIe 4.0 on PEG Lanes #8-15 (H-series only)
USB	4x USB 3.2 Gen 2 8x USB 2.0	4x USB 3.2 Gen2 (incl. USB 2.0) + 4x USB 2.0
DDI	3x	3x DP++ (DDI1-3)
LVDS/eDP	1x Dual Channel	1x Dual Channel 18/24bit (eDP instead of LVDS)
VGA	1x	1x (optional)
SATA	4x	2x SATA Gen3
HD Audio	1x	1x
SPI	1x	1x
GSPI	1x	1x
eSPI/LPC	1x	1x
SMB	1x	1x
I2C	1x	1x
UART	2x	2x
GPIO	8x	8x

Table 2: Type 6 and COMe-bRP6 functionality

2.5 COM Express® Benefits

COM Express® defines a Computer-On-Module (COM), with all the components necessary for a bootable host computer, packaged as a highly integrated computer. All Kontron COM Express® modules are very compact and feature a standardized form factor and a standardized connector layout that carry a specified set of signals. Each COM module is based on the COM Express® specification. This standardization allows designers to create a single-system carrier board that can accept present and future COM Express® modules.

The carrier board designer can optimize exactly how each of these functions implements physically. Designers can place connectors precisely where needed for the application, on a carrier board optimally designed to fit a system's packaging.

A single carrier board design can use a range of COM Express® modules with different sizes and pinouts. This flexibility differentiates products at various price and performance points and provides a built-in upgrade path when designing future-proof systems. The modularity of a COM Express® solution also ensures against obsolescence when computer technology evolves. A properly designed COM Express® carrier board can work with several successive generations of COM Express® modules.

A COM Express® carrier board design has many advantages of a customized computer-board design and, additionally, delivers better obsolescence protection, heavily reduced engineering effort, and faster time to market.

3. Product Specification

3.1 Module Variants

The COMe-bRP6 is available in different processor, memory and temperature variants to cover demands in performance, price and power.

3.1.1 Commercial Grade Modules (0°C to +60°C)

Part Number	Product Name	Description
38040-0000-25-7	COMe-bRP6 i7-13800HE	COM Express® basic pin-out type 6 Computer-on-Module with Intel® Core™ i7-13800HE, 6×2.5GHz, 2x DDR5 non-ECC SO-DIMM
38040-0000-27-5	COMe-bRP6 i5-13600HE	COM Express® basic pin-out type 6 Computer-on-Module with Intel® Core™ i5-13600HE, 4×2.7GHz, 2x DDR5 non-ECC SO-DIMM
38040-0000-21-3	COMe-bRP6 i3-13300HE	COM Express® basic pin-out type 6 Computer-on-Module with Intel® Core™ i3-13300HE, 4×2.1GHz, 2x DDR5 non-ECC SO-DIMM
38040-0000-19-7	COMe-bRP6 i7-1370PE	COM Express® basic pin-out type 6 Computer-on-Module with Intel® Core™ i7-1370PE, 6×1.9GHz, 2x DDR5 non-ECC SO-DIMM
38040-0000-18-5	COMe-bRP6 i5-1350PE	COM Express® basic pin-out type 6 Computer-on-Module with Intel® Core™ i5-1350PE, 4×1.8GHz, 2x DDR5 non-ECC SO-DIMM
38040-0000-17-3	COMe-bRP6 i3-1320PE	COM Express® basic pin-out type 6 Computer-on-Module with Intel® Core™ i3-1320PE, 4×1.7GHz, 2x DDR5 non-ECC SO-DIMM

Table 3: Commercial Grade Modules (0°C to +60°C operating)

3.1.2 Extended Temperature Grade Modules (E1, -25°C to +75°C)

There are none versions planned for E1 temperature range (-25°C to +75°C) due to Intel® DTR (Dynamic Temperature Range) limitation.



For further information on Intel® DTR (Dynamic Temperature Range) limitation, contact [Kontron Support](#) team.

3.1.3 Industrial Temperature Grade Modules (E2, -40°C to +85°C)

Part Number	Product Name	Description
38041-0000-25-7	COMe-bRP6 E2 i7-13800HRE	COM Express® basic pin-out type 6 Computer-on-Module with Intel® Core™ i7-13800HRE, 6×2.5GHz, 2x DDR5 non-ECC SO-DIMM, industrial temperature grade
38041-0000-27-5	COMe-bRP6 E2 i5-13600HRE	COM Express® basic pin-out type 6 Computer-on-Module with Intel® Core™ i5-13600HRE, 4×2.7GHz, 2x DDR5 non-ECC SO-DIMM, industrial temperature grade
38041-0000-21-3	COMe-bRP6 E2 i3-13300HRE	COM Express® basic pin-out type 6 Computer-on-Module with Intel® Core™ i3-13300HRE, 4×2.1GHz, 2x DDR5 non-ECC SO-DIMM, industrial temperature grade
38041-0000-19-7	COMe-bRP6 E2 i7-1370PRE	COM Express® basic pin-out type 6 Computer-on-Module with Intel® Core™ i7-1370PRE, 6×1.9GHz, 2x DDR5 non-ECC SO-DIMM, industrial temperature grade
38041-0000-18-5	COMe-bRP6 E2 i5-1350PRE	COM Express® basic pin-out type 6 Computer-on-Module with Intel® Core™ i5-1350PRE, 4×1.8GHz, 2x DDR5 non-ECC SO-DIMM, industrial temperature grade
38041-0000-17-3	COMe-bRP6 E2 i3-1320PRE	COM Express® basic pin-out type 6 Computer-on-Module with Intel® Core™ i3-1320PRE, 4×1.7GHz, 2x DDR5 non-ECC SO-DIMM, industrial temperature grade

Table 4: Industrial Temperature Grade Modules (-40°C to +85°C operating)

3.2 Accessories

Accessories are product specific, COMe-type 6 specific or general COMe accessories. For more information, contact your local Kontron Sales Representative or Kontron Inside Sales.

Part Number	Carrier	Description
38116-0000-00-0	COMe Eval Carrier2 T6	COM Express® Eval Carrier 2 Type 6
38116-0000-00-5	COMe Eval Carrier2 T6 5mm	COM Express® Eval Carrier 2 Type 6 with 5mm COMe connector
Part Number	Cooling	Description
38040-0000-99-0	HSP COMe-bRP6 Cu-core threaded	Heatspreader for COMe-bRP6, Cu-core, threaded mounting holes
38040-0000-99-1	HSP COMe-bRP6 Cu-core through	Heatspreader for COMe-bRP6, Cu-core, through mounting holes
38025-0000-99-0C05	HSK COMe-Basic active (w/o HSP)	Active Cooler for COMe-bRP6/bxL6/bV26/bDV7/bID7 to be mounted on HSP
38025-0000-99-0C06	HSK COMe-Basic passive (w/o HSP)	Passive Cooler for COMe-bRP6/bxL6/bV26/bDV7/bID7 to be mounted on HSP
Part Number	Fan Cables	Description
96079-0000-00-0	KAB-HSP 200mm	Cable adapter for FAN to module connection with cable length 200mm
96079-0000-00-2	KAB-HSP 40mm	Cable adapter for FAN to module connection with cable length 40mm
Part Number	Mounting	Description
38017-0000-00-0	COMe Mount Kit 8mm 1set	Mounting Kit for 1 module with screws for 8mm COMe connector
38017-0000-00-5	COMe Mount Kit 5mm 1set	Mounting Kit for 1 module with screws for 5mm COMe connector
Part Number	Memory	Description
97040-3248-BRP6	DDR5-4800 SODIMM 32GB_BRP6	DDR5-4800, 32GB, 262P, 2400MHz, PC5-4800 SODIMM (0°C to +60°C)
97040-1648-BRP6	DDR5-4800 SODIMM 16GB_BRP6	DDR5-4800, 16GB, 262P, 2400MHz, PC5-4800 SODIMM (0°C to +60°C)
97040-0848-BRP6	DDR5-4800 SODIMM 8GB_BRP6	DDR5-4800, 8GB, 262P, 2400MHz, PC5-4800 SODIMM (0°C to +60°C)
97041-3248-BRP6	DDR5-4800 SODIMM 32GB E2_BRP6	DDR5-4800, 32GB, 262P, 2400MHz, PC5-4800 SODIMM (-40°C to +85°C)
97041-1648-BRP6	DDR5-4800 SODIMM 16GB E2_BRP6	DDR5-4800, 16GB, 262P, 2400MHz, PC5-4800 SODIMM (-40°C to +85°C)
97041-0848-BRP6	DDR5-4800 SODIMM 8GB E2_BRP6	DDR5-4800, 8GB, 262P, 2400MHz, PC5-4800 SODIMM (-40°C to +85°C)

Table 5: Accessories

3.3 Functional Specification

3.3.1 Technical Data

Function	Definition
Compliance	COM Express® Basic Pin-out Type 6
Dimension (H X W)	125 x 95 mm
Processors	Intel® 13 th Generation Core™ family: Core™ i7-13800HE, Core™ i5-13600HE, Core™ i3-13300HE, Core™ i7-13800HRE, Core™ i5-13600HRE, Core™ i3-13300HRE, Core™ i7-1370PE, Core™ i5-1350PE, Core™ i3-1320PE, Core™ i7-1370PRE, Core™ i5-1350PRE, Core™ i3-1320PRE
Chipset	Integrated SoC
Main Memory	2x DDR5 SO-DIMM with up to 32 GByte per channel (non-ECC)
Graphics Controller	Intel® Iris® Xe Graphics on i7/i5 processors Intel® UHD Graphics on i3 processors
Display	DDI1: DP++, DDI2: DP++, DDI3: DP++, VGA: -, LVDS: Dual Channel 18/24bit
Ethernet Controller	Intel® I226LM/I226IT
Ethernet	Up to 2.5 Gb Ethernet with TSN support (ind. SKUs only)
Storage	2x SATA 6 Gb/s
Flash Onboard	Up to 1 TByte NVMe SSD (on request)
PCI Express	5x PCIe 3.0 (On request: 6x without Ethernet, up to 8x without Ethernet & SATA or alternatively 8x with additional PCIe Switch) 2x 4 PCIe 4.0 on PEG Lanes #0-7 1x 8 PCIe 4.0 on PEG Lanes #8-15 (H-series only)
USB	4x USB 3.2 Gen2 (incl. USB 2.0) + 4x USB 2.0
Serial	2x serial interface (RX/TX only)
Audio	High Definition Audio interface
Other Features	(G)SPI, LPC, SMB, Fast I ² C, Staged Watchdog, RTC
Special Features	Trusted Platform Module TPM 2.0
Features on Request	vPRO (AMT/TXT/AES Support), eDP instead of LVDS, VGA, USB-C, up to 3x PCIe x1 additional w/o Ethernet & SATA, NVMe SSD, Fail Safe via 2nd SPI Flash
Power Management	ACPI 6.0
Power Supply	8.5 V - 20 V Wide Range, Single Supply Power
BIOS	AMI Aptio V
Operating Systems	Windows®10, Linux, VxWorks (project based)
Temperature	Commercial temperature: 0 °C to +60 °C operating, -30 °C to +85 °C non-operating Industrial temperature: -40 °C to +85 °C operating, -40 °C to +85 °C non-operating
Humidity	93 % relative Humidity at 40 °C, non-condensing (according to IEC 60068-2-78)

Table 6: Technical Data

3.3.2 Block Diagram

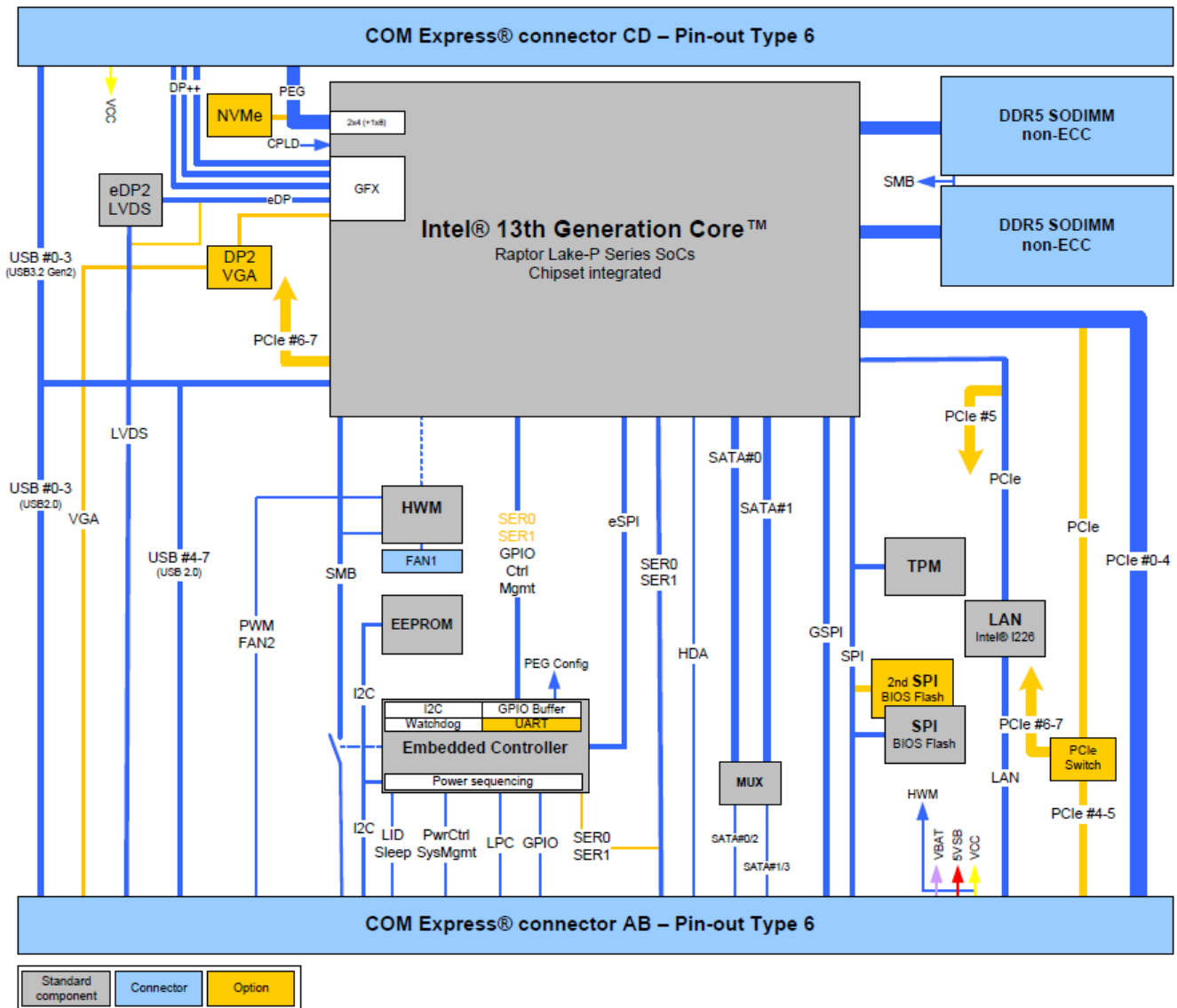

Figure 1: Block Diagram COMe-brp6

3.3.3 Front View

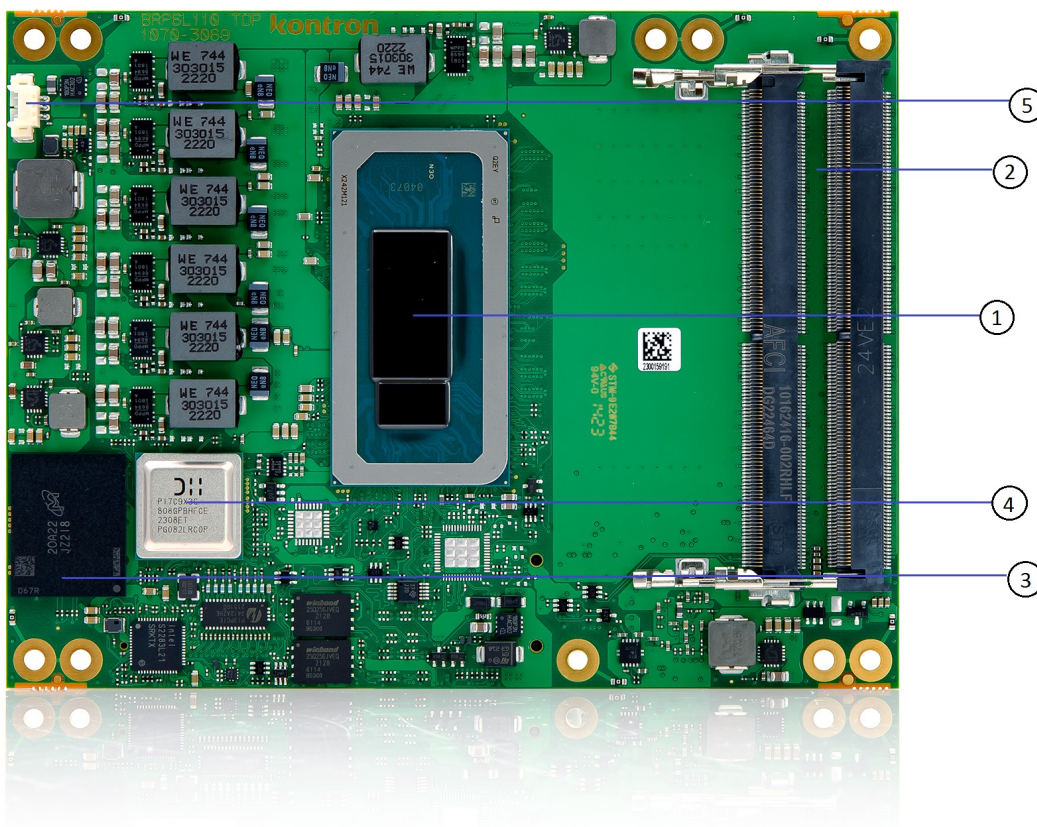

Figure 2: Front View COMe-bRP6

1. SoC - Processor (CPU) & Chipset (PCH)
2. DDR5 SO-DIMM sockets
3. Optional NVMe SSD
4. Optional PCIe Switch
5. 3-pin fan connector

3.3.4 Rear View

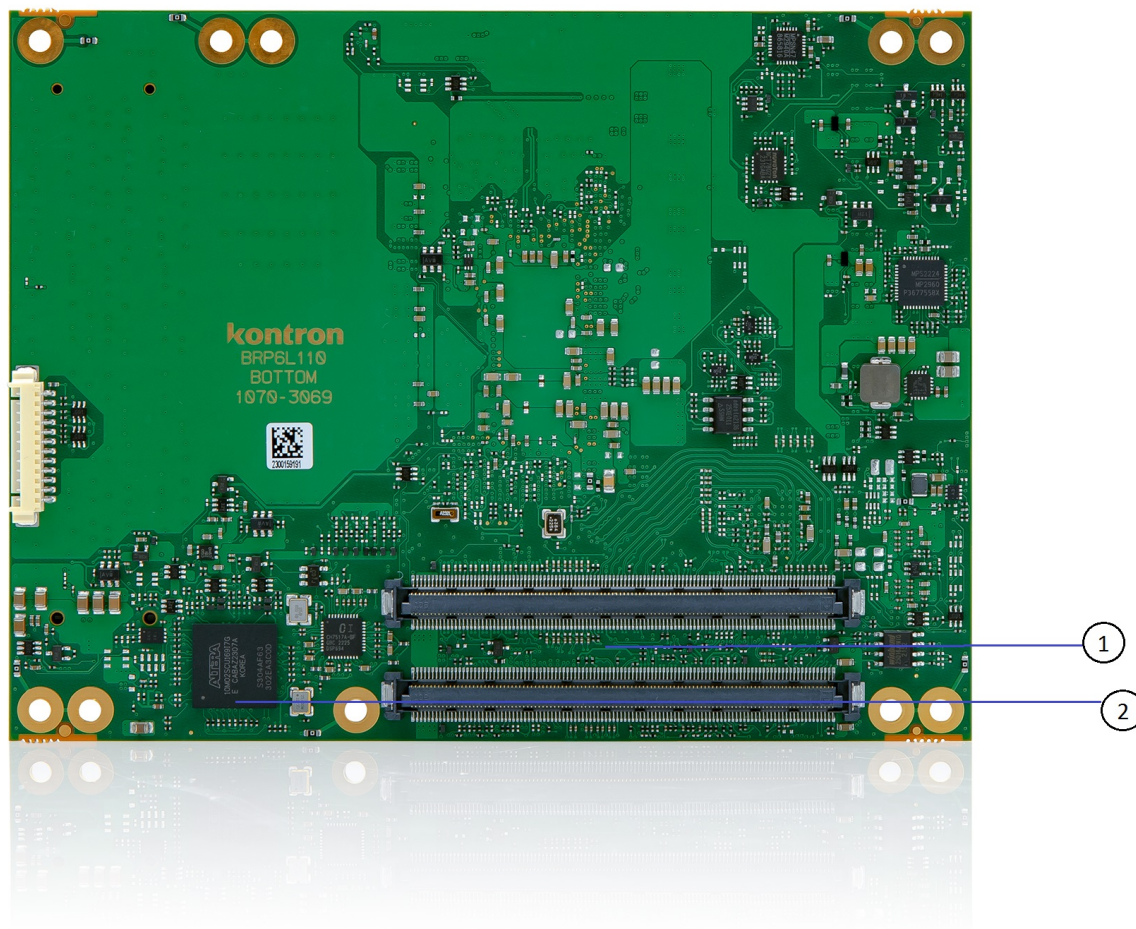

Figure 3: Rear View COMe-bRP6

1. COMe connectors
2. Embedded Controller

3.3.5 Processor (CPU)

The 13th Gen Intel® Core™ mobile processors combine power efficiency, performance, flexibility, and industrial-grade features to drive success for demanding AI, graphics, and rugged edge use cases. This new generation offers a performance hybrid architecture with up to 14 cores and flexible processor base power from 15W to 45W.

13th Gen Intel Core mobile processors also offer enhanced Intel® Iris® X^e Graphics for fast, power-efficient parallel AI processing and immersive visual experiences. And with industrial-grade features and ruggedized SKUs, this lineup will enable advanced intelligence and real-time performance in the most-challenging environments.

Key features are:

- Intel® 7 process technology
- Up to 14 cores, up to 20 threads in IoT SKUs
- Up to 24 MB Intel® Smart Cache
- Processor base power range of 15W to 45W
- Intel® Iris® X^e Graphics with up to 96 execution units (EUs)
- Support for up to four concurrent displays at up to 4K resolution or one display at 8K resolution
- Pipelock video synchronization for Windows, graphics and display virtualization
- Intel® Deep Learning Boost (Intel® DL Boost) with VNNI instructions
- Up to DDR5-4800; LP5x-6400
- Up to 8 lanes PCIe 4.0 + 8 lanes PCIe 5.0 (H-series) off the CPU, up to 12 lanes PCIe 3.0 off the PCH
- Intel vPro® platform eligible on select SKUs
- Long-life availability
- Windows 10 IoT Enterprise 2021 LTSC, Yocto Project Linux, UEFI, Slim Bootloader
- Thunderbolt™ 4 or USB 4
- Integrated 1GbE port, 2.5GbE discrete LAN
- Support for Intel® TCC/TSN on ind. SKUs
- IB ECC memory on ind. SKUs
- Extended temperature (-40°C to 100°C Tjmax) on ind. SKUs

Processor Number	Processor Cores	Number of P-cores	Number of E-cores	Number of Threads	Intel® Smart Cache (L3)	P-Core Base Freq (GHz)	E-Core Base Freq (GHz)	Max P-Core Turbo Freq (GHz)	Max E-Core Turbo Freq (GHz)	Processor Graphics	Number of Execution Units (EUs)	Intel vPro® Platform
Intel® Core™ i7-13800H(R)E processor	14	6	8	20	24MB	2.5 (@45W) 1.8 (@35W)	1.8	Up to 5.0	Up to 4.0	Intel® Iris® X ^e Graphics	96	Yes
Intel® Core™ i5-13600H(R)E processor	12	4	8	16	18MB	2.7 (@45W) 1.9 (@35W)	1.9	Up to 4.8	Up to 3.6	Intel® Iris® X ^e Graphics	80	Yes
Intel® Core™ i3-13300H(R)E processor	8	4	4	12	12MB	2.1 (@45W) 1.2 (@35W)	1.5	Up to 4.6	Up to 3.4	Intel® UHD Graphics	48	No

Table 7: Processor lineup - 13th Gen Intel® Core™ processors (H-series 45W)

Processor Number	Processor Cores	Number of P-cores	Number of E-cores	Number of Threads	Intel® Smart Cache (L3)	P-Core Base Freq (GHz)	E-Core Base Freq (GHz)	Max P-Core Turbo Freq (GHz)	Max E-Core Turbo Freq (GHz)	Processor Graphics	Number of Execution Units (EUs)	Intel vPro® Platform
Intel® Core™ i7-1370P(R)E processor	14	6	8	20	24MB	1.9 (@28W) 1.3 (@20W)	1.2	Up to 4.8	Up to 3.7	Intel® Iris® Xe Graphics	96	Yes
Intel® Core™ i5-1350P(R)E processor	12	4	8	16	12MB	1.8 (@28W) 1.2 (@20W)	1.3	Up to 4.6	Up to 3.4	Intel® Iris® Xe Graphics	80	Yes
Intel® Core™ i3-1320P(R)E processor	8	4	4	12	12MB	1.7 (@28W) 1.2 (@20W)	1.2	Up to 4.5	Up to 3.3	Intel® UHD Graphics	48	No

Table 8: Processor lineup - 13th Gen Intel® Core™ processors (P-series 28W)

3.3.6 Platform Controller Hub (PCH)

The 13th Gen Intel® Core™ mobile SoCs provide an On-Package PCH based on the Intel® 700 Series Chipset family.

3.3.7 System Memory

The COMe-bRP6 uses a Dual-Channel memory configuration with two DDR5 SODIMMs which enables a maximum system memory capacity of 64 GByte. Depending on the internal structure of used RAM chips a maximum transfer rate of 4800 MT/s can be achieved. IB ECC (In-Band error-correcting code) is supported by the integrated PCH of the 13th Gen Intel® Core™ mobile SoCs. The following table summarizes the specific system memory features:

Type	SODIMM DDR5-4800
Densities	16 Gbit
Channels	2
Capacity (max.)	64 GByte
Speed (max.)	4800 MT/s
ECC/IB ECC	Yes

Table 9: System Memory

The two SODIMM memory sockets are located on the top side of the module where socket one is 4 mm and socket two is 8 mm high. Each socket may be populated with a DDR5 SODIMM mounted horizontally.

In general, memory modules have a much lower longevity than the corresponding COM Express® boards. Therefore an EOL of the memory modules may occur several times during the lifetime of the board. Kontron guarantees to maintain memory modules regularly and to replace EOL memory modules with another qualified module.

At least, it is recommended to use Kontron memory modules for prototype system(s) in order to prove the stability of the system and as a reference. For volume production, if required, it is possible to test and qualify other types of similar memory modules. In order to qualify these it is recommended to configure three systems running a RAM Stress Test program in a heat chamber at 60°C resp. 85°C, for a minimum of 24 hours.



For a list of Kontron memory modules, see chapter 3.2

3.3.8 High-Speed Interface Overview

The On-Package PCH of the 13th Gen Intel® Core™ mobile SoCs offers 12 High-Speed I/O lanes. The following table shows the internal High-Speed I/O lane multiplexing in the PCH and the default usage on the COMe-bRP6.

HSIO Lane#	HSIO Type	COMe-bRP6 Default	COMe-bRP6 Option	COMe Ports
0	USB3.2 / PCIe #1	USB3.2 #1	USB3.2 #1	USB3.2 #0
1	USB3.2 / PCIe #2	USB3.2 #2	USB3.2 #2	USB3.2 #1
2	USB3.2 / PCIe #3	USB3.2 #3	USB3.2 #3	USB3.2 #2
3	USB3.2 / PCIe #4	USB3.2 #4	USB3.2 #4	USB3.2 #3
4	PCIe #5	PCIe #5	PCIe #5	PCIe #0
5	PCIe #6	PCIe #6	PCIe #6	PCIe #1
6	PCIe #7 / GbE	PCIe #7	PCIe #7	PCIe #2
7	PCIe #8 / GbE	PCIe #8	PCIe #8	PCIe #3
8	PCIe #9 / GbE / UFS	PCIe #9	PCIe #9	PCIe #4
9	PCIe #10 / UFS	ETH	PCIe #10	ETH / PCIe #5
10	PCIe #11 / SATA 0	SATA 0	PCIe #11 / SATA 2	SATA 0/2 / PCIe #6
11	PCIe #12 / SATA 1	SATA 1	PCIe #12 / SATA 3	SATA 1/3 / PCIe #7

Table 10: HSIO Mapping

3.4 Interfaces

3.4.1 PCI Express

COM Express® Type 6 modules support up to 24 PCI Express lanes. A subset of these PCI Express lanes are commonly used as PCI Express Graphics (PEG) lanes.

General Purpose PCI Express 3.0

COMe	PCH HSIO Lane#	Used HSIO Type	Supported Lane Configuration		
PCIE_0	4	PCIe #5	x1	x2	x4
PCIE_1	5	PCIe #6	x1		
PCIE_2	6	PCIe #7	x1	x2	
PCIE_3	7	PCIe #8	x1		
PCIE_4	8	PCIe #9	x1	x2	x4
PCIE_5 (w/o ETH)	9	PCIe #10	x1		
PCIE_6 (w/o SATA 0/2)	10	PCIe #11	x1	x2	
PCIE_7 (w/o SATA 1/3)	11	PCIe #12	x1		

Table 11: General Purpose PCIe Gen3

As COMe PCIE_5, 6 and 7 are used for Ethernet and SATA by default, these ports are only available as a configuration option (see chapter 3.3.8). This also applies to the related PCIe lane configurations.

COMe PCIE_4 can alternatively be connected to an optional PCIe Switch in order to extend the General Purpose PCIe Gen3 lanes by PCIe [4:7] Gen2.

PCI Express Graphics 4.0/5.0 (PEG)

In addition to the PCIe Gen3 lanes provided by the On-Package PCH, up to 16 additional PCIe Gen4/5 lanes are provided by the CPU which are routed to the PEG ports on the COMe-bRP6.

COMe	CPU	Supported Lane Configuration	PCIe Gen
PEG_0	PCIEX4_A_0	x4	Gen4
PEG_1	PCIEX4_A_1		Gen4
PEG_2	PCIEX4_A_2		Gen4
PEG_3	PCIEX4_A_3		Gen4
PEG_4 (w/o NVMe)	PCIEX4_B_0	x4	Gen4
PEG_5 (w/o NVMe)	PCIEX4_B_1		Gen4
PEG_6 (w/o NVMe)	PCIEX4_B_2		Gen4
PEG_7 (w/o NVMe)	PCIEX4_B_3		Gen4

COMe	CPU	Supported Lane Configuration	PCIe Gen
PEG_8	PCIEX8_0	x8	Gen5
PEG_9	PCIEX8_1		Gen5
PEG_10	PCIEX8_2		Gen5
PEG_11	PCIEX8_3		Gen5
PEG_12	PCIEX8_4		Gen5
PEG_13	PCIEX8_5		Gen5
PEG_14	PCIEX8_6		Gen5
PEG_15	PCIEX8_7		Gen5

Table 12: PCI Express Graphics Gen4/5 (PEG)

The PCIEx4_A lanes can either be connected to COMe PEG lanes [0:3] or to an optional PCIe Switch in order to extend the General Purpose PCIe Gen3 lanes by PCIe [4:7].

The PCIEX4_B lanes can either be connected to COMe PEG lanes [4:7] or to an optional onboard NVMe Flash SSD.

Processor x4 and x8 PCIe Gen4/5 interface does not support further bifurcation configurations. Moreover, it supports fixed lane reversal only.

The PCIEX8 lanes are only available on H-Series SKUs.



The default PCIe configuration of the COMe-bRP6 is 5×1 + 2×4 (+ 1×8). To change the default PCIe configuration (5×1), a new BIOS version is required. For BIOS version information, visit [Kontron's Customer Section](#) or contact [Kontron Support](#).



Full PCIe Gen5 capabilities are not expected due to general COM Express® connector limitation

3.4.2 Universal Serial Bus (USB)

COM Express® Type 6 boards provide up to eight USB 2.0 ports. Up to four of these can be used as USB 3.2 Gen 1 or Gen 2 ports.

Each USB 3.2 port implemented is comprised of a USB 2.0 port and an USB SuperSpeed TX pair and RX pair.

Therefore, the number of available USB 2.0 only ports decreases with every used USB 3.2 Gen 1 or Gen 2 port.

The COMe-bRP6 offers four USB 3.2 Gen 2 ports with 10 Gb/s (including USB 2.0) and four dedicated USB 2.0 ports.

COMe	PCH USB Port	Description
USB0	USB32_1 USB2_1	USB 3.2 Gen 2×1 (10 Gb/s) or USB 2.0
USB1	USB32_2 USB2_2	USB 3.2 Gen 2×1 (10 Gb/s) or USB 2.0
USB2	USB32_3 USB2_3	USB 3.2 Gen 2×1 (10 Gb/s) or USB 2.0
USB3	USB32_4 USB2_4	USB 3.2 Gen 2×1 (10 Gb/s) or USB 2.0
USB4	USB2_5	USB 2.0 (dedicated)
USB5	USB2_6	USB 2.0 (dedicated)
USB6	USB2_7	USB 2.0 (dedicated)
USB7	USB2_8	USB 2.0 (dedicated)

Table 13: USB 3.2 Gen 2 / USB 2.0 Port Configuration

3.4.3 Serial ATA (SATA)

COM Express® Type 6 modules support up to four SATA ports.

The COMe-bRP6 offers two SATA Gen 3 ports with 6 Gb/s.

COMe	PCH HSIO Lane#	HSIO Type	Description
SATA0	10	SATA 0	SATA 6 Gb/s
SATA1	11	SATA 1	SATA 6 Gb/s
SATA2	-	-	Optional instead of SATA 0
SATA3	-	-	Optional instead of SATA 1

Table 14: SATA Port Connections

SATA2/3 can be used optional instead of SATA0/1 via the appropriate configuration in the BIOS setup.

3.4.4 Ethernet

The Intel® I226LM/IT Ethernet Controller is connected to PCH HSIO Lane #9 (PCIe #10) to provide 2500BASE-T to the carrier.

3.4.5 Graphics Interfaces

COM Express® Type 6 boards can support up to three Digital Display Interfaces (DDI) to provide DisplayPort and HDMI/DVI modes, a single or dual channel 18/24 bit LVDS panel interface and an eDP overlaid on LVDS Channel A. The manner in which LVDS or eDP operation is chosen is vendor dependent.

The COMe-bRP6 implements the Intel® Iris® X^e Graphics architecture with up to 96 Execution Units (EUs) depending on the processor variant. With up to four display pipes the modules support up to four concurrent displays at up to 4K resolution or one 8K display.



If more than one active display port is connected, then the processor frequency may be lower than base frequency in thermally limited scenarios.

	Raptor Lake-P
Displays	4 Display Pipes - 4 Independent Displays - 4x4K60 HDR
HDMI	Native HDMI 2.1 TMDS compatible HDMI 2.1 via DP to HDMI protocol convertor
DP	DP2.1 (up to UHBR20) via TCSS w/ Hayden Bridge DP 1.4a HBR3 w/ VDSC 1.1 8K60 HDR external display
eDP	eDP 1.4b HBR3 w/ VDSC 1.1, 5K120 HDR internal panel
3D Graphics HW Acceleration	DX12, Mesa 3D, Open GL 4.6, Vulkan 1.2
HW Media Acceleration	OneVPL
HW Video Decode	8K60 12b 4:2:0 HEVC/VP9/SCC 8K30 10b 4:2:0 AV1 5K60 10b 4:4:4 HEVC/VP9/SCC 4K60 8b 4:2:0 AVC
HW Video Encode	8K30 or 5K60 8b/10b 4:2:0 HEVC/VP9/SCC 4K60 10b 4:4:4 HEVC/VP9/SCC 4K60 8b 4:2:0 AVC
Content Protection	HDCP 2.3

Table 15: Display and Media Capabilities



Please check in detail the graphics capabilities of the used CPU as these may differ depending on the SKU.

The COMe module offers three DDI (DP++) ports which can be used as HDMI via a passive DP-to-HDMI adapter. Additionally an eDP-to-LVDS bridge supports 18/24 bit LVDS by default. Furthermore VGA can be provided by an optional DP2VGA Bridge to support corresponding legacy applications or for maintenance purposes.

COMe Port/ Display Type	CPU Port	Description
DDI1 (DP++)	TCP0	Standard on all product variants
DDI2 (DP++)	TCP1	Standard on all product variants
DDI3 (DP++)	TCP2	Standard on all product variants
VGA	TCP3	Optional via DP2VGA Bridge
LVDS/eDP	DDIA	LVDS (default), eDP (option)

Table 16: COMe-bRP6 Graphics Interfaces



Kontron recommends only using a DP-to-HDMI or DP-to-DVI passive adapter that is compliant to the DP Dual-Mode standard. If adapters are used with FET level shifter for DCC translation, display detection issues may occur.



To increase link margin, at 4K resolution a DP redriver on the carrier is recommended.



Kontron strongly recommends the use of flat panels that support Extended Display Identification data (EDID) when connecting to the LVDS interface.



An external LVDS EEPROM can be connected to the LVDS-I2C bus at COMe connector pins A83 and A84. Don't connect other devices to this bus.

3.4.6 Audio Interfaces

COM Express® Type 6 modules can support following audio interfaces:

- SoundWire
- HD Audio

The COMe-bRP6 provides HD Audio by default using the processor's DDIs and carrier board audio using a HDA codec. SoundWire can be offered as an untested assembly option.

3.4.7 UART Serial Ports

Two TTL compatible two wire asynchronous serial ports are available on COM Express® module Types 6, 7 and 10.

COMe Signal
SER0_TX
SER0_RX
SER1_TX
SER1_RX

Table 17: UART Serial Ports

Data out is on the _TX pins. Hardware handshaking and hardware flow control are not supported. The module asynchronous serial ports are intended for general purpose use and for use with debugging software that make use of the “console redirect” features available in many operating systems.

On the COMe-bRP6 both serial ports are provided via PCIe by the On-Package PCH by default. For Windows/Linux appropriate drivers are delivered by the corresponding OS Board Support Package (BSP) stored on [Kontron’s Customer Section](#). For other configurations like Legacy UART support please contact [Kontron Support](#) team for further details.

3.4.8 General Purpose SPI interface

Latest COM Express® specification (Rev. 3.1) introduces a General purpose Serial Peripheral Interface (GSPI) with dedicated pins (using RSVD pins of the former pinout) to connect multiple peripherals.

To maintain backward compatibility to predecessor designs, it's possible to connect the GSPI interface to COMe Boot SPI pins via an assembly option as well.

COMe Signal	Optional COMe Connection	Alder Lake-P
GP_SPI_CS#	SPI_CS#	GSPI0_CS0# / GPP_E10
GP_SPI_MISO	SPI_MISO	GSPI0_MISO / GPP_E12
GP_SPI_MOSI	SPI_MOSI	GSPI0_MOSI / GPP_E13
GP_SPI_CLK	SPI_CLK	GSPI0_CLK / GPP_E11

Table 18: GSPI on COMe-bRP6

3.4.9 Boot SPI

The Serial Peripheral Interface (SPI) is a synchronous serial communication interface. Devices communicate in master-slave mode, where the master-device initiates the data frame. Multiple slave-devices may be supported through selection with individual chip select (CS) lines.

On COMe-bRP6 SPI0 is routed to the COMe connector. The SPI interface may only be used with a serial flash device on the carrier board to boot an external BIOS firmware.

COMe Signal	Raptor Lake-P	Description
SPI_CS#	SPI0_CS0#	Chip select for Carrier Board SPI
SPI_MISO	SPI0_MISO	Bidirectional data path for Carrier Board SPI flash
SPI_MOSI	SPI0_MOSI	Bidirectional data path for Carrier Board SPI flash
SPI_CLK	SPI0_CLK	Clock from the Module to Carrier Board SPI
SPI_POWER	-	Connected to V_3V3_SPI
BIOS_DIS0#	-	Inputs to control SPI_CS# routing logic that is handled by the CPLD
BIOS_DIS1#	-	

Table 19: SPI on COMe-bRP6

3.4.10 LPC/eSPI

The Low Pin Count (LPC) interface is pin shared with eSPI. A COM Express® Type 6 module design may support either LPC or eSPI or both.

As LPC isn't provided by the Alder Lake-P platform an eSPI-to-LPC bridge is implemented on the COMe-bRP6 via the onboard CPLD per Default.

ESPI_EN# is available for the carrier to signal to the module whether LPC or eSPI is to be used. If ESPI_EN# is unconnected on the carrier, LPC operation is expected. For eSPI operation ESPI_EN# has to be connected to GND on the carrier. To be able to detect the correct mode of operation, the module uses a pull-up resistor on this signal.



The module will not boot up if module and carrier configuration do not match.

COMe Connector Pin	LPC Mode Connection (from CPLD)	eSPI mode connection (from PCH)
B[4:7]	LPC_AD[0:3]	ESPI_IO_[0:3]
B3	LPC_FRAME#	ESPI_CS0#
B10	LPC_CLK	ESPI_CK
B[8:9]	LPC_DRQ[0:1]	ESPI_ALERT[0:1]#
A50	LPC_SERIRQ	ESPI_CS1#
B18	SUS_STAT#	ESPI_RESET#
B47		ESPI_EN#

Table 20: LPC/eSPI mode comparison



For eSPI usage a HW modification and customized BIOS according to the customer's requirements is necessary. For further help on this please contact [Kontron Support](#).

3.4.11 I2C

Two I2C buses are generated by the onboard CPLD.

The external I2C bus transfers data between I2C devices connected on the bus, the internal one between components on the module itself.

The Fast I2C bus transfers data with rates up to 400 kHz. To change the I2C bus speed in the BIOS setup menu select:

Advanced>Miscellaneous>I2C Speed> 1 kHz to 400 kHz

The default speed is 200 kHz.

External user-accessible I2C (I2C_EXT)

The following table specifies the devices connected to the accessible I2C bus including the I2C address. This I2C bus is available at COMe connector pins I2C_CK, I2C_DAT.

8-bit Address	7-bit Address	Device
0xA0	0x50	Module Embedded EEPROM (JIDA EEPROM)
0xAE	0x57	Carrier EEPROM (optional)
0x64	0x32	External RTC (optional)

Table 21: I2C Bus Port Address (I2C_EXT)

Internal I2C (I2C_INT)

The second I2C bus is primarily used for configuration of onboard devices, but also for an external LVDS EEPROM.

8-bit Address	7-bit Address	Device
0xA0	0x50	External LVDS EEPROM

Table 22: I2C Bus Port Address (I2C_INT)

3.4.12 General Purpose IOs (GPIOs)

The COMe-bRP6 offers 8 GPIOs, generated by the onboard CPLD, on the dedicated COM Express® pins. The type of termination resistor used sets the direction of the GPIO, where GPI terminations are pull-up resistors, and GPO terminations are pull-down resistors.

Due to the fact that both the pull-up and pull-down termination resistors are weak, it is possible to override the termination resistors using external pull-ups, pull-downs or IOs. Overriding the termination resistors means that the eight GPIO pins can be considered as bi-directional since there are no restrictions whether you use the available GPIO pins in the in- or out-direction.

Configuration can be adjusted by the OS driver.

3.4.13 SMBus

The System Management Bus (SMBus) is a simple 2-wire bus for low-speed system management communication. The (On-Package) PCH controls the SMBus. It is used on the module to manage system functions such as reading the DRAM SPD EEPROM or to control the Hardware Monitor.

On the carrier board the SMBus is useful e.g. for Smart Battery implementations. If the SMBus is used externally great care must be taken to avoid conflicts with the onboard SMBus devices.

The SMBus address uses the LSB (Bit 0) for the direction of the device.

Bit0 = 0 defines the write address

Bit0 = 1 defines the read address

The following table specifies the SMBus write address for onboard devices.

8-bit Address	7-bit Address	Device
0x5C	0x2E	Hardware Monitor
0xAC	0x56	Hardware Monitor (reserved)

Table 23: SMBus Write Address



Don't use this addresses for external devices under any circumstances.

3.5 Features

3.5.1 ACPI Power States

ACPI enables the system to power down, save power when not required (suspend) and wake up when required (resume).

ACPI controls the power states S0-S5, where S0 has the highest priority and S5 the lowest priority.

S0	Working state
S1	Sleep (typically not supported anymore)
S2	Deep Sleep (typically not supported anymore)
S3	Suspend-to-RAM
S4	Suspend-to-disk / Hibernate
S5	Soft-off state

Table 24: ACPI Power States Function



Not all ACPI defined power states are available.
The COMe-bRP6 supports ACPI 6.0 and the power states S0, S3, S4, S5 only.
Systems that support the low-power idle state do not use power states S3 and S4.

To power on from states S3, S4 and S5 use

- Power Button
- WakeOnLAN (S3, S4)



The OS must support wake up from an USB device and the carrier board must power the USB port with the standby voltage.

3.5.2 Embedded Controller - Hardware Monitor

Embedded Controller (CPLD)

The Embedded (Module System Management) Controller resp. the therefore used CPLD is connected to COMe-bRP6 eSPI interface to provide several interfaces and features to the module/carrier:

- UARTs (optional, by default UARTs from On-Package PCH are used)
- LPC Bus (via eSPI-to-LPC bridge)
- I2C Bus
- GPIOs
- Watchdog

Moreover, the CPLD is responsible for platform power sequence and reset control for all components.

Hardware Monitor (HWM)

The Hardware Monitor (HWM) controls the health of the system by monitoring critical aspects such as the module's processor temperature, power supply voltages (VCC/5VSB) or battery voltage V_BAT and monitors/configures the FAN control onboard as well as to COMe. The HWM is accessible via the SMBus, see chapter 3.4.13.

3.5.3 Trusted Platform Module (TPM)

The COMe-bRP6 supports a TPM chip which is directly connected to SPI0 (dedicated SPI interface from On-Package PCH).

3.5.4 Watchdog Timer (WDT)

The watchdog timer interrupt is a hardware or software timer implemented by the module to the carrier board if there is a fault condition in the main program; the watchdog triggers a system reset or other corrective actions after a specific time, with the aim to bring the system back from a non-responsive to normal state.

The COMe-bRP6 supports an independently programmable watchdog that works with two stages that can be used stage by stage.

Time-Out Event	Description
No action	Stage is off and will be skipped
Reset	Restarts the module and starts a new POST and Operating System
NMI	A non-maskable interrupt (NMI) is a computer processor interrupt that cannot be ignored by standard interrupt masking techniques in the system. It is used typically to signal attention for non-recoverable hardware errors
SMI	A system management interrupt (SMI) makes the processor entering the system management mode (SMM). As such, specific BIOS code handles the interrupt. The current BIOS handler for the watchdog SMI currently does nothing. For special requirements, contact Kontron Support
SCI	A system control interrupt (SCI) is a OS-visible interrupt to be handled by the OS using AML code
Delay → No action	Might be necessary when an operating system must be started and the time for the first trigger pulse must be extended. Only available in the first stage
WDT only	Triggers WDT pin on the carrier board connector only
Reset + WDT	—
NMI + WDT	—
SMI + WDT	—
SCI + WDT	—
Delay + WDT → No action	—

Table 25: Dual Staged Watchdog Timer - Time-Out Events

WDT Signal

WDT interrupt on COM Express® connector pin B27 indicates a Watchdog time-out event has not been triggered within a set time. The WDT signal is configurable to any of the two stages. After reset, the signal is automatically de-asserted. If de-assertion is necessary during runtime, contact [Kontron Support](#) for further help.

3.5.5 Real-Time Clock (RTC)

The RTC keeps track of the current time accurately. The RTC's low power consumption enables the RTC to continue operation and keep time using a lower secondary source of power while the primary source of power is switched off or unavailable.

The COMe-bRP6 supports typical RTC values of 3 V and less than 10 μ A. When powered by the main power supply on-module regulators generate the RTC voltage, to reduce RTC current draw. The RTC's battery voltage range is 2.8 V to 3.47 V.



It is not recommended to run a system without a RTC battery on the carrier board. Even if the RTC battery is not required to keep the actual time and date when main power is off, a missing RTC battery will cause other side effects such as longer boot times. Intel processor environments are generally designed to rely on RTC battery voltage.

3.5.6 NVMe

On COMe-bRP6 a PCIe NVMe NAND Flash SSD (with a capacity up to 1TB) can be populated optionally, connected to the PCIEX4_B lanes instead of COMe PEG lanes [4:7] (see chapter 3.4.1).



There are different types of NVMe SSDs available from different vendors. For further information on offered resp. released types and their particular feature set, contact [Kontron Support](#).

3.5.7 Boot SPI Device

A 32 MByte SPI Flash device supporting SFDP (Serial Flash Discovery Parameter) is connected to SPI0 (dedicated SPI interface from On-Package PCH). Flash Descriptor, BIOS, converged security engine as well as platform data are stored within the SPI Flash.

The COMe-bRP6 supports on-module and carrier boot from SPI. It does not support Slave Attached File Sharing (SAFS) configurations (i.e. BIOS can't be attached to eSPI via an Embedded Controller/Board Management Controller).

COMe signals BIOS_DIS0#, BIOS_DIS1# and ESPI_EN# are used to select the desired boot source (see table below).

Config#	ESPI_EN#	BIOS_DIS1#	BIOS_DIS0#	Boot Bus	PCH CS1#	PCH CS0#	CS# to COMe Carrier	SPI Descriptor	Description
1	1	0	0	SPI	Carrier	Module	PCH CS1#	Module	MAFS on Module / LPC enabled
2	1	0	1	SPI	Module	Carrier	PCH CS0#	Carrier	MAFS on Carrier / LPC enabled
3	1	1	0	-	-	-	-	-	Not used
4	1	1	1	SPI	Module	Module	High	Module	MAFS on Module / LPC enabled
5	0	0	0	SPI	Carrier	Module	PCH CS1#	Module	MAFS on Module / eSPI enabled
6	0	0	1	SPI	Module	Carrier	PCH CS0#	Carrier	MAFS on Carrier / eSPI enabled
7	0	1	0	eSPI	-	-	-	-	Not supported (SAFS configuration)
8	0	1	1	eSPI	-	-	-	-	Not supported (SAFS configuration)

Table 26: BIOS Boot Options



If ESPI_EN# selection of the carrier does not match the module configuration (LPC/eSPI) the module won't boot.



The BIOS cannot be split between two chips. Booting takes place either from the on-module SPI Flash chip or the SPI Flash device on the carrier board.

Size	Manufacturer	Part Number	Package Type
32 MByte (256 Mbit)	Macronix	MX25L25645GZ2I-08G	WSO8-8
32 MByte (256 Mbit)	Micron	MT25QL256ABA1EW9-0SIT	WSO8-8
32 MByte (256 Mbit)	Winbond	W25Q256JVEIQ	WSO8-8
32 MByte (256 Mbit)	Cypress	S25FL256LAGNFI010	WSO8-8

Table 27: Supported SPI Flash Devices

On request, a second SPI Flash device can be populated on the module for additional safety. Fail Safe Operation (automatic switchover) has to be implemented in the CPLD in that case. For further information on the Fail Safe feature and project based requirements resp. adjustments, contact [Kontron Support](#).

3.5.8 Embedded EEPROM

The module's 32 kbit serial EEPROM (formerly known as JIDA EEPROM) device is attached to the I2C bus (I2C_EXT) from the CPLD and accessible via I2C bus 8-bit address 0x0A (see chapter 3.4.11).

3.6 Electrical Specification

The module powers on by connecting to a carrier board via the COMe interface connectors. The COMe interface connector pins on the module limits the amount of power received.



Before connecting the module's interface connector to the carrier board's corresponding connector, ensure that the carrier board is switched off and disconnected from the main power supply. Failure to disconnect the main power supply could result in personal injury and damage to the module and/or carrier board.



Observe that only trained personnel aware of the associated dangers connect the module, within an access controlled ESD-safe workplace.

3.6.1 Power Supply Specification

The power specification of the module supports a single supply voltage of 12 V and a wide input voltage range of 8.5 V to 20 V. Other supported voltages are 5 V standby and 3.3 V RTC battery input.

Supply Voltage Range (VCC)	8.5 V to 20 V
Supply Voltage (VCC)	12 V \pm 5%
Standby Voltage (VCC_5V_SBY)	5 V \pm 5%
RTC Voltage (VCC_RTC)	2.8 V to 3.47 V

Table 28: Supported Supply Voltages



Standby voltage is not mandatory for operation.



Only connect to an external power supply delivering the specified input rating and complying with the requirements of Safety Extra Low Voltage (SELV) and Limited Power Source (LPS) of UL/IEC 60950-1 or (PS2) of UL/IEC 62368-1.



To protect external power lines of peripheral devices, make sure that the wires have the right diameter to withstand the maximum available current and the enclosure of the peripheral device fulfils the fire-protection requirements of IEC/EN 62368-1.



If any of the supply voltages drops below the allowed operating level longer than the specified hold-up time, all the supply voltages should be shut down and left OFF for a time long enough to allow the internal board voltages to discharge sufficiently.

If the OFF time is not observed, parts of the board or attached peripherals may work incorrectly or even suffer a reduction of MTBF. The minimum OFF time depends on the implemented PSU model and other electrical factors and must be measured individually for each case.

Power Supply Voltage Rise Time

The input voltage rise time is 0.1 ms to 20 ms from input voltage $\leq 10\%$ to nominal input voltage. To comply with the ATX specification there must be a smooth and continuous ramp of each DC input voltage from 10 % to 90 % of the DC input voltage final set point.

Power Supply Voltage Ripple

The maximum power supply voltage ripple and noise is 100 mV peak-to-peak measured over a frequency bandwidth of 0 MHz to 20 MHz. The voltage ripple, must not cause the input voltage range to be exceeded.

Power Supply Inrush Current

The maximum inrush current at 5V Standby is 2 A. From states G3 (module is mechanically completely off, with no power consumption) or S5 (module appears to be completely off) to state S0 (module is fully usable) the maximum inrush current meets the SFX Design Guide.

3.6.2 Power Management

The Advanced Configuration and Power Interface (ACPI) 6.0 hardware specification supports features such as power button and suspend states. The power management options are available within the BIOS set up menu: **Advance>ACPI Settings>**

Suspend States

If power is removed, 5V can be applied to the VCC_5V_SBY pins to support the ACPI suspend-states:

- Suspend-to-RAM (S3)
- Suspend-to-disk (S4)
- Soft-off (S5)



If power is removed, the wake-up event (S0) requires VCC to power on the module for normal operation.

Power Supply Control Settings

Power supply control settings are set in the BIOS and enable the module to shut down, rest and wake from standby.

COMe Signal	Pin	Description
Power Button (PWRBTN#)	B12	A PWRBTN# falling edge signal creates a power button event ($50 \text{ ms} \leq t < 4 \text{ s}$, typical 400 ms, at low level). Power button events can be used to bring a system out of S5 soft-off and other suspend states, as well as powering the system down. Pressing the power button for at least four seconds turns off power to the module (Power Button Override).
Power Good (PWR_OK)	B24	Indicates that all power supplies to the module are stable within specified ranges. PWR_OK signal goes active and module internal power supplies are enabled. PWR_OK can be driven low to prevent module from powering up until the carrier is ready and releases the signal. PWR_OK should not be deactivated after the module enters S0 unless there is a power fail condition.
Reset Button (SYS_RESET#)	B49	When the SYS_RESET# pin is detected active (falling edge triggered), it allows the processor to perform a “graceful” reset, by waiting up to 25 ms for the SMBus to enter the idle state before forcing a reset, even though activity is still occurring. Once reset is asserted, it remains asserted for 5 ms to 6 ms regardless of whether the SYS_RESET# input remains asserted or not.
Carrier Board Reset (CB_Reset#)	B50	When CB_Reset# from module to carrier is active low, the module outputs a request to the carrier board to reset.
SMBus Alert (SMB_ALERT#)	B15	When external battery manager is present and SMB_ALERT# connected, the module powers on even if the BIOS switch “After Power Fail” is set to “Stay Off”.
Battery Low (BATLOW#)	A27	BATLOW# indicates that the external battery is low and provides a battery-low signal to the module for orderly transitioning to power saving or power cut-off ACPI modes.
PCIe Wake-up (WAKE0#)	B66	Indicates PCIe wake-up signal
GP Wake-up (WAKE1#)	B67	Indicates general purpose wake-up signal
Suspend Control (SUS_STAT#)	B18	SUS_STAT# indicates an imminent suspend operation. Used to notify LPC devices.
Suspend-to-RAM (SUS_S3#)	A15	Indicates system is in Suspend-to-RAM state. Active low output.
Suspend-to-disk (SUS_S4#)	A18	Indicates system is in Suspend-to-disk state. Active low output.
Soft-off (SUS_S5#)	A24	Indicates system is in Soft-off state. Active low output.

COMe Signal	Pin	Description
Lid detection (LID#)	A103	Low active signal used by the ACPI operating system for a LID switch.
Sleep button (SLEEP#)	B103	Low active signal used by the ACPI operating system to bring the system to sleep state or to wake it up again.

Table 29: Power Supply Control Settings



After a complete power loss (including battery voltage), there is an additional cold reset. This additional reset will not happen on any subsequent warm or cold reboots.

3.6.3 Power Supply Modes

The COMe-bRP6 is operating in either ATX power mode or single power supply mode.

ATX Mode

To start the module in ATX mode, connect VCC and 5V Standby from a ATX PSU. As soon as the standby rail ramped up the PCH enters S5 state and starts the transition to S0. SUS_S3# (usually connected to PSU PS_ON#) turns on the main power rail (VCC). As soon as the PSU indicates that the power supply is stable (PWR_OK high) the PCH continues transition to S0.



The input voltage must always be higher than 5V Standby ($VCC > 5V_SBY$) for modules supporting a wide input voltage range down to 8.5V.

State	PWRBTN#	PWR_OK	5V_SBY	PS_ON#	VCC
G3	x	x	0V	x	0V
S5	high	low	5V	high	0V
S5 → S0	PWRBTN Event	low → high	5V	high → low	0V → VCC
S0	high	high	5V	low	VCC

x: Not relevant for the specific power state. There is no difference if connected or open

Table 30: ATX Mode Settings

Single Power Supply Mode

To start the module in single power supply mode, connect VCC power and open PWR_OK at the high level. VCC can be 8.5 V to 20 V. To power on the module from S5 state, press the power button or reconnect VCC.



Suspend/Standby states are not supported in single power supply mode.

State	PWRBTN#	PWR_OK	5V_SBY	VCC
G3	0V/x	0V/x	0V/x	0V/x
S5	high	open / high	open	VCC
S5 → S0	PWRBTN Event	open / high	open	reconnecting VCC
G3 → S0	high	open / high	open	connecting VCC

x: Not relevant for the specific power state. There is no difference if connected or open

Table 31: Single Power Supply Mode Settings



All ground pins must be connected to the carrier board's ground plane.



If any of the supply voltages drops below the allowed operating level longer than the specified hold-up time, all the supply voltages should be shut down and left OFF for a time long enough to allow the internal board voltages to discharge sufficiently. If the OFF time is not observed, parts of the board or attached peripherals may work incorrectly or even suffer a reduction of MTBF. The minimum OFF time depends on the implemented PSU model and other electrical factors and needs to be measured individually for each case.

3.7 Thermal Management

3.7.1 Heatspreader Plate Assembly

A heatspreader plate assembly is available from Kontron for the COMe-bRP6. The heatspreader plate assembly is NOT a heatsink. The heatspreader plate transfers heat as quickly as possible from the processor using a copper core positioned directly above the processor and a Thermal Interface Material (TIM). The heatspreader plate is factory prepared with a TIM screen printed on the contacts and may be fasten to the module without additional user actions.

The heatspreader plate works as a COM Express® standard thermal interface and must be used with a heatsink or external cooling devices to maintain the heatspreader plate at proper operating temperatures. Under worst-case conditions, the cooling mechanism must maintain an ambient air and heatspreader plate temperature on any spot of the heatspreader's surface according the module's specification:

- 60°C for commercial temperature grade modules
- 75°C for extended temperature grade modules (E1)
- 85°C for industrial temperature grade modules (E2)

3.7.2 Active/Passive Cooling Solutions

Both active and passive thermal management approaches can be used with the heatspreader plates. The optimum cooling solution depends on the application and environmental conditions. Kontron's active or passive cooling solutions are designed to cover the power and thermal dissipation for a commercial temperature range used in housing with a suitable airflow.

3.7.3 Operating with Kontron Heatspreader Plate (HSP) Assembly

The operating temperature requirements are:

- Maximum ambient temperature with ambient being the air surrounding the module
- Maximum measurable temperature on any position on the heatspreader's surface

Temperature Grade	Requirements
Commercial Grade	At 60°C HSP temperature the MCP @ 100% load needs to run at nominal frequency
Extended Grade(E1)	At 75°C HSP temperature the MCP @ 75% load is allowed to start throttling for thermal protection
Industrial Grade (E2)	At 85°C HSP temperature the MCP @ 50% load is allowed to start throttling for thermal protection

Table 32: Heatspreader Temperature Specification

3.7.4 Operating without Kontron Heatspreader Plate (HSP) Assembly

The operating temperature is the maximum measurable temperature on any spot of the module's surface.

3.7.5 Temperature Sensors

The module's processor is capable of reading its internal temperature. The on-module Hardware Monitor (HWM) chip uses an on-chip temperature sensor to measure the modules's temperature on the board.

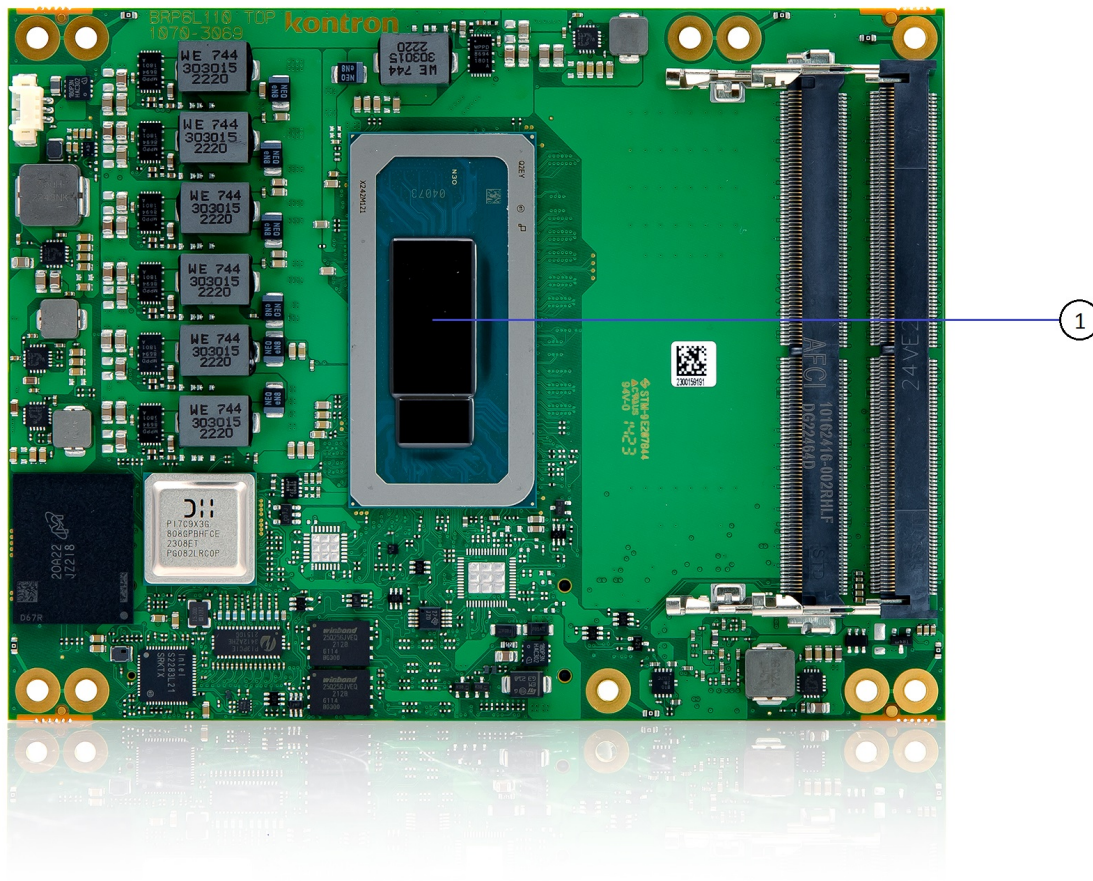

Figure 4: 1. Temperature Sensor in Processor (CPU)

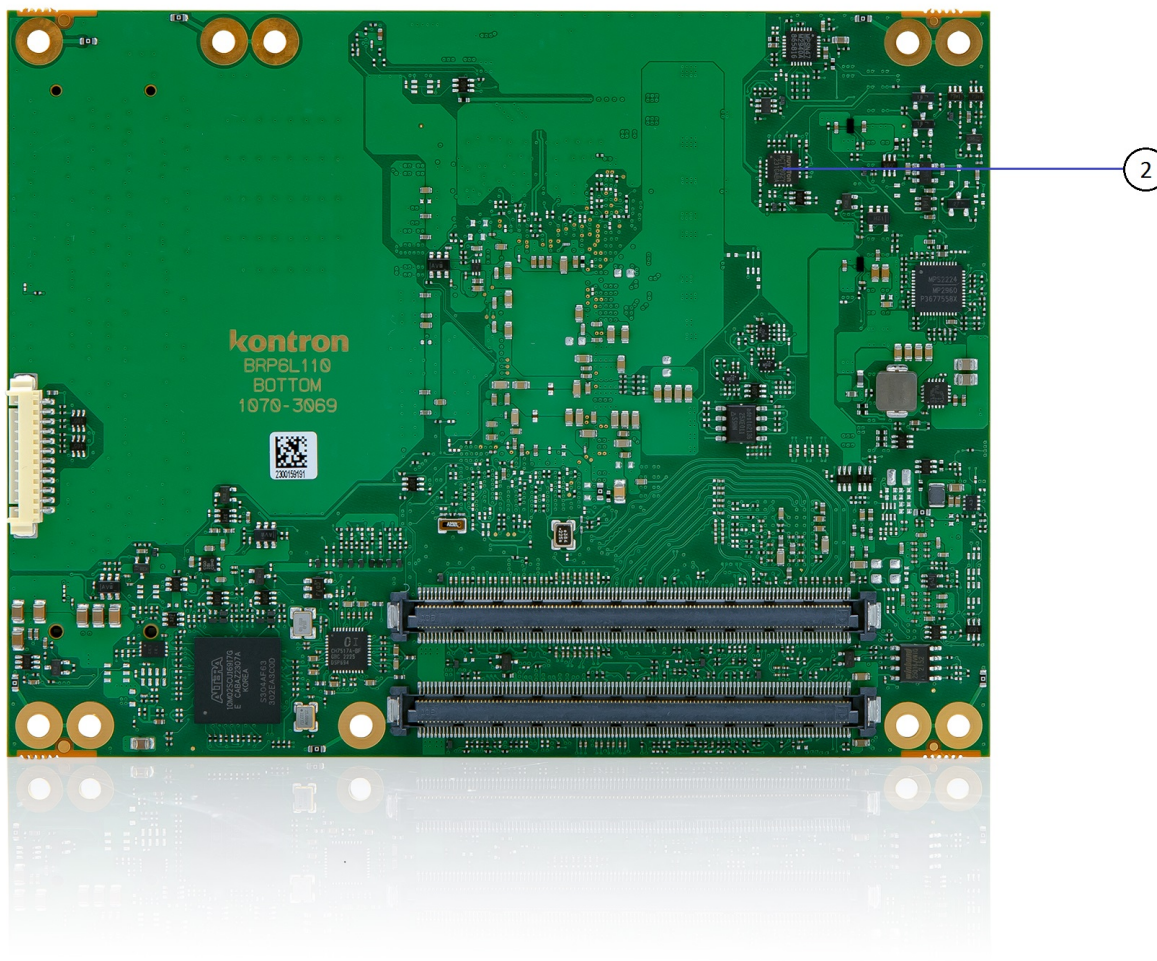

Figure 5: 2. Temperature Sensor in Hardware Monitor (HWM)

3.7.6 On-Module Fan Connector

The module's fan connector powers, controls and monitors an external fan. To connect a standard 3-pin connector fan to the module, use Kontron's fan cable (see chapter 3.2).

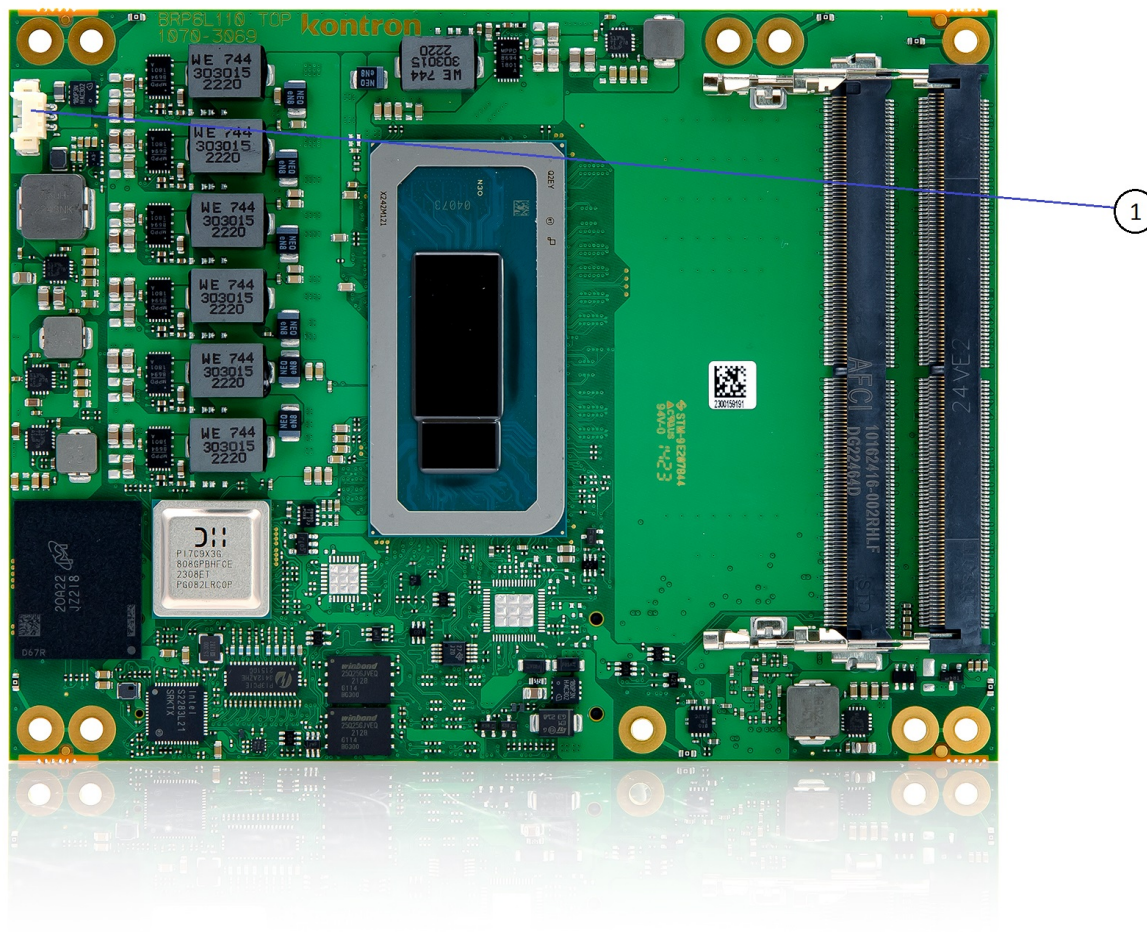

Figure 6: 1. On-Module 3-Pin Fan Connector

The analog output voltage on this connector is generated via a discrete linear voltage regulator from the PWM signal of the HWM. It is clipped at 12 V (+/- 10 %) across the whole input range of the module to prevent fan damage at higher voltages.

The maximum supply current to the fan is 350 mA if the input voltage is below 13 V and is further limited to 150 mA if the input voltage to the module is between 13 V and 20 V.

Pin	Signal	Description	Type
1	FAN_TACH_IN#	Fan input voltage from COMe connector	Input
2	V_FAN	12 V \pm 10% (max.) across module input range	PWR
3	GND	Power GND	PWR

Table 33: Fan Connector Pin Assignment



Always check the fan specification according to the limitations of the supply current and supply voltage.

3.8 Mechanical Specification

The COMe-bRP6 is compatible with the COM Express® mechanical specification.

3.8.1 Module Dimensions

The COMe basic module dimensions are 125 mm x 95 mm (4.9" x 3.7").

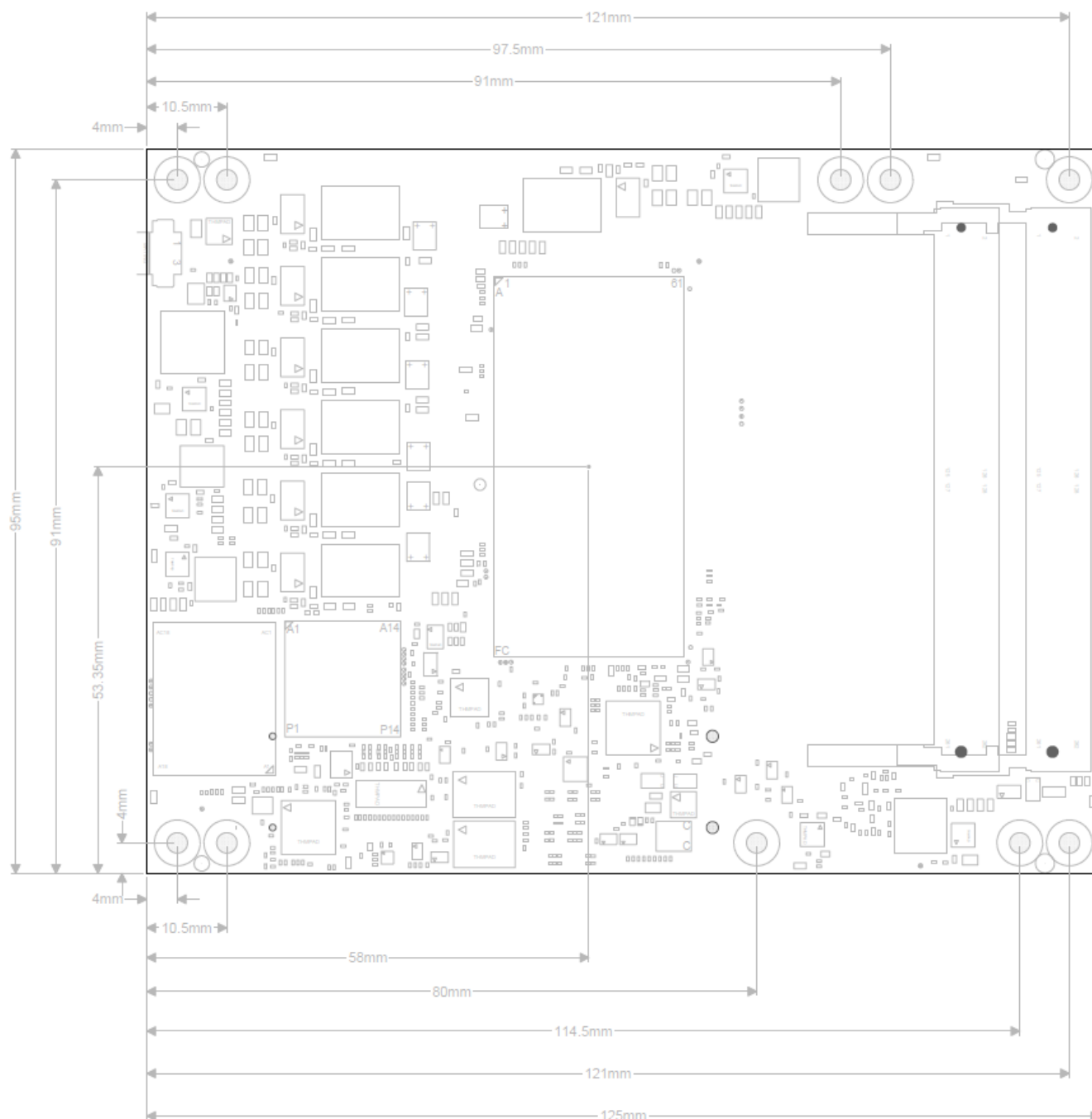

Figure 7: Module Dimensions

3.8.2 Module Height

The COM Express® specification defines a module height of approximately 13mm, when measured from the bottom of the module's PCB board to the top of the heatspreader. The overall height of the module and carrier board depends on

- which carrier board connectors are used (5mm and 8mm height are available)
- which cooling solution is used. The height of the cooling solution is not specified in the COM Express® specification.

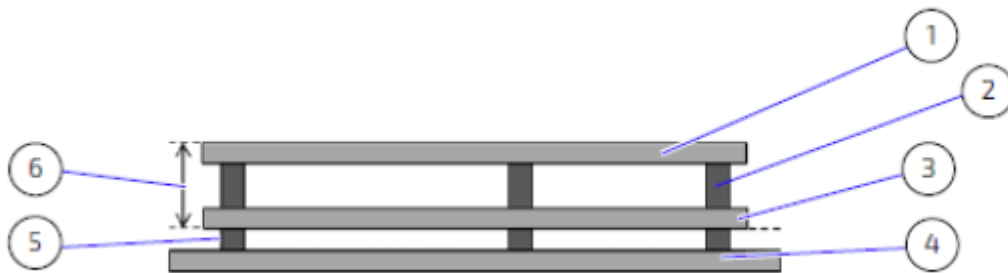

Figure 8: Module and Carrier Height

1. Heatspreader
2. Heatspreader Standoffs
3. Module PCB
4. Carrier Board PCB
5. 5 or 8 mm Connector/Standoffs
6. 13 mm +/- 0.65 mm

3.8.3 Heatspreader Plate Assembly Dimensions

The module's cooling concept uses a heatspreader plate assembly fasten on the module via the heatspreader plate standoffs. The heatspreader plate works as a COM Express® standard thermal interface and must be used with a heatsink or external cooling device to maintain the heatspreader plate at proper operating temperatures.

For heatspreader plate drawings and 3D models check our [Customer Section](#).

3.9 Environmental Specification

The COMe-bRP6 supports industrial temperature grade only.

Environmental		Description
Industrial Grade (E2)	Operating	-40°C to +85°C (-40°F to 185°F)
	Non-operating	-40°C to +85°C (-40°F to 185°F)
Relative Humidity		93 % @40°C, non-condensing
Shock (according to IEC 60068-2-27)		Non-operating shock test (half-sinusoidal, 11ms, 15g)
Vibration (according to IEC 60068-2-6)		Non-operating vibration (sinusoidal, 10 Hz to 2000 Hz, +/- 0.15 mm, 2 g)

Table 34: Environmental Specification

3.10 Compliance

The COMe-bRP6 complies with the following or the latest status thereof. If modified, the prerequisites for specific approvals may no longer apply. For more information, contact [Kontron Support](#).

Europe - CE Mark	
Directives	2014/30/EU : Electromagnetic Compatibility 2014/35/EU : Low Voltage 2011/65/EU : RoHS II 2001/95/EC : General Product Safety
EMC	EN 55032 Class B : Electromagnetic compatibility of multimedia equipment - Emission Requirements Class A EN 61000-6-2 : Electromagnetic compatibility (EMC) Part 6-2: Generic standards - Immunity standard for industrial environments
Safety	EN 62368-1 : Audio/video, information and communication technology equipment - Part 1: Safety requirements

Table 35: Compliance CE Mark

USA/Canada	
Safety	UL 62368-1 & CSA C22.2 No. 62368-1 (Component Recognition) : Audio/video, information and communication technology equipment - Part 1: Safety requirements Recognized by Underwriters Laboratories Inc. Representative samples of this component have been evaluated by UL and meet applicable UL requirements. UL listings: AZOT2.E147705 AZOT8.E147705
UK CA Mark	
EMC	BS EN 55032 Class B : Electromagnetic compatibility of multimedia equipment - Emission Requirements Class A BS EN 61000-6-2 : Electromagnetic compatibility (EMC) Part 6-2: Generic standards - Immunity standard for industrial environments
Safety	BS EN 62368-1 : Audio/video, information and communication technology equipment - Part 1: Safety requirements
CB scheme (For International Certifications)	
Safety	IEC 62368-1 : Audio/video, information and communication technology equipment - Part 1: Safety requirements

Table 36: Country Compliance



If the product is modified, the prerequisites for specific approvals may no longer apply.



Kontron is not responsible for any radio television interference caused by unauthorized modifications of the delivered product or the substitution or attachment of connecting cables and equipment other than those specified by Kontron. The correction of interference caused by unauthorized modification, substitution or attachment is the user's responsibility.

3.11 MTBF

The MTBF (Mean Time Before Failure) values were calculated using a combination of the manufacturer's test data (if available) and the Telcordia (Bellcore) issue 2 calculation for the remaining parts.

The Telcordia calculation used is "Method 1 Case 3" in a ground benign, controlled environment. This particular method takes into account varying temperature and stress data and the system is assumed to have not been burned-in. Other environmental stresses (such as extreme altitude, vibration, salt-water exposure) lower MTBF values.

	MTBF Value @40°C	Part Number
MTBF (hours)	586365	38041-0000-25-7

Table 37: MTBF



The MTBF estimated value above assumes no fan, but a passive heat sinking arrangement. Estimated RTC battery life (as opposed to battery failures) is not accounted for and needs to be considered separately. Battery life depends on both temperature and operating conditions. When the module is connected to external power, the only battery drain is from leakage paths.

4. COMe Interface Connector

The COMe-bRP6 is a COM Express® Type 6 module containing two 220-pin connectors J1 and J2; each with two rows called row A & B on the primary connector J1 and row C & D on the secondary connector J2.

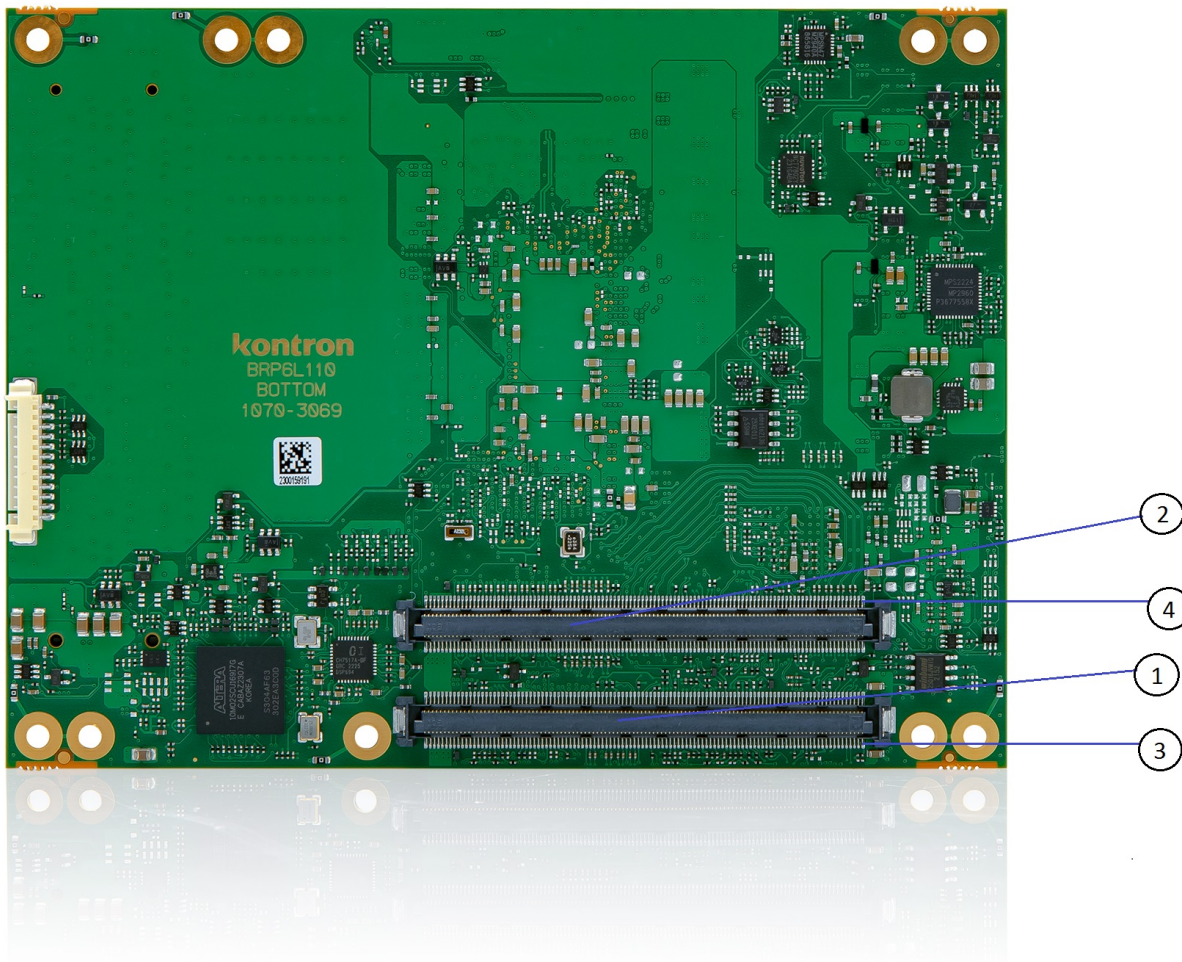

Figure 9: COMe Interface Connectors

1. COMe interface connector (J1)
2. COMe interface connector (J2)
3. Connector J1 - Pin A1
4. Connector J2 - Pin D1

4.1 Connecting COMe Interface Connector to Carrier Board

The COMe interface connectors (J1, J2) are inserted into the corresponding connectors on the carrier board and secured using the mounting points and standoffs. The height of the standoffs (either 5 mm or 8 mm) depends on the height of the carrier board's connector.



The module is powered on by connecting to the carrier board using the interface connector. Before connecting the module's interface connector to the carrier board's corresponding connector, ensure that the carrier board is switched off and disconnected from the main power supply. Failure to disconnect the main power supply could result in personal injury and damage to the module and/or carrier board.

Observe that only trained personnel aware of the associated dangers connect the module, within an access controlled ESD-safe workplace.



To protect external power lines of peripheral devices, make sure that the wires have the right diameter to withstand the maximum available current. The enclosure of the peripheral device fulfills the fire-protection requirements of IEC/EN 62368.

4.2 J1 and J2 Signals

For a description of the terms used in the J1 and J2 pin assignment tables, see table given below. If a more detailed pin assignment description is required, refer to PICMG® COM.0 Revision 3.1 Base Specification.

Type	Description	Type	Description
NC	Not Connected (on this product)	O-1.8	1.8 V Output
I/O-3.3	Bi-directional 3.3 V I/O-Signal	O-3.3	3.3 V Output
I/O-5T	Bi-dir. 3.3 V I/O (5 V tolerance)	O-5	5 V Output
I/O-5	Bi-directional 5V I/O-Signal	DP-I/O	Differential Pair Input/Output
I-3.3	3.3 V Input	DP-I	Differential Pair Input
I/OD	Bi-directional Input/Output Open Drain	DP-O	Differential Pair Output
I-5T	3.3 V Input (5 V tolerance)	PU/PD	Pull-Up/Pull-Down Resistor
OA	Output Analog	PWR	Power Connection
OD	Output Open Drain	+/-	Differential Pair Differentiator

Table 38: General Signal Description



The pin assignment tables list the internal pull-ups (PU) or pull-downs (PD) implemented by the chip vendors.

4.3 Connector J1 Pinout

4.3.1 Pins A1 - A110

Pin	Signal	Description	Type	Termination	Comment
A1	GND	Power Ground	PWR GND	—	—
A2	GBE0_MDI3-	Ethernet Media Dependent Interface 3 -	DP-I/O	—	—
A3	GBE0_MDI3+	Ethernet Media Dependent Interface 3 +	DP-I/O	—	—
A4	GBE0_LINK100#	Ethernet Speed LED	OD	—	—
A5	GBE0_LINK1000#	Ethernet Speed LED	OD	—	—
A6	GBE0_MDI2-	Ethernet Media Dependent Interface 2 -	DP-I/O	—	—
A7	GBE0_MDI2+	Ethernet Media Dependent Interface 2 +	DP-I/O	—	—
A8	GBE0_LINK#	LAN Link LED	OD	—	—
A9	GBE0_MDI1-	Ethernet Media Dependent Interface 1 -	DP-I/O	—	—
A10	GBE0_MDI1+	Ethernet Media Dependent Interface 1 +	DP-I/O	—	—
A11	GND	Power Ground	PWR GND	—	—
A12	GBE0_MDI0-	Ethernet Media Dependent Interface 0 -	DP-I/O	—	—
A13	GBE0_MDI0+	Ethernet Media Dependent Interface 0 +	DP-I/O	—	—
A14	GBE0_CTREF	Center Tab Reference Voltage	O	—	100nF capacitor to GND
A15	SUS_S3#	Suspend-to-RAM (or deeper) Indicator	O-3.3	PD 100k	—
A16	SATA0_TX+	SATA Transmit Pair 0 +	DP-O	AC Coupled on Module	—
A17	SATA0_TX-	SATA Transmit Pair 0 -	DP-O	AC Coupled on Module	—
A18	SUS_S4#	Suspend-to-disk (or deeper) Indicator	O-3.3	PD 100k	—
A19	SATA0_RX+	SATA Receive Pair 0 +	DP-I	AC Coupled on Module	—
A20	SATA0_RX-	SATA Receive Pair 0 -	DP-I	AC Coupled on Module	—
A21	GND	Power Ground	PWR GND	—	—
A22	SATA2_TX+	SATA Transmit Pair 2 +	DP-O	—	Optional instead of SATA0
A23	SATA2_TX-	SATA Transmit Pair 2 -	DP-O	—	Optional instead of SATA0

Pin	Signal	Description	Type	Termination	Comment
A24	SUS_S5#	Soft-off Indicator	O-3.3	PD 100k	—
A25	SATA2_RX+	SATA Receive Pair 2 +	DP-I	—	Optional instead of SATA0
A26	SATA2_RX-	SATA Receive Pair 2 -	DP-I	—	Optional instead of SATA0
A27	BATLOW#	Battery Low	I-3.3	PU 10k 3.3V (S5)	Assertion will prevent wake from S3-S5 state
A28	(S)ATA_ACT#	Serial ATA activity LED	OD-3.3	PU 10k 3.3V (S0)	—
A29	HDA_SYNC	HD Audio Sync	O-3.3	—	—
A30	HDA_RST#	HD Audio Reset	O-3.3	PD 100k	—
A31	GND	Power Ground	PWR GND	—	—
A32	HDA_BITCLK	HD Audio Bit Clock Output	O-3.3	PD 100k	—
A33	HDA_SDOUT	HD Audio Serial Data Out	O-3.3	—	—
A34	BIOS_DIS0#/ESPI_SAFS	BIOS Selection Strap 0	I-3.3	PU 10k 3.3V (S5)	—
A35	THRMTRIP#	Thermal Trip	IO33-OD	PU 10k 3.3V (S0)	—
A36	USB6-	USB 2.0 Data Pair Port 6 -	DP-I/O	PD 14.25k to 24.8k in PCH	—
A37	USB6+	USB 2.0 Data Pair Port 6 +	DP-I/O	PD 14.25k to 24.8k in PCH	—
A38	USB_6_7_OC#	USB Overcurrent Indicator Port 6/7	I-3.3	PU 10k 3.3V (S5)	—
A39	USB4-	USB 2.0 Data Pair Port 4 -	DP-I/O	PD 14.25k to 24.8k in PCH	—
A40	USB4+	USB 2.0 Data Pair Port 4 +	DP-I/O	PD 14.25k to 24.8k in PCH	—
A41	GND	Power Ground	PWR GND	—	—
A42	USB2-	USB 2.0 Data Pair Port 2 -	DP-I/O	PD 14.25k to 24.8k in PCH	—
A43	USB2+	USB 2.0 Data Pair Port 2 +	DP-I/O	PD 14.25k to 24.8k in PCH	—
A44	USB_2_3_OC#	USB Overcurrent Indicator Port 2/3	I-3.3	PU 10k 3.3V (S5)	—
A45	USB0-	USB 2.0 Data Pair Port 0 -	DP-I/O	PD 14.25k to 24.8k in PCH	—
A46	USB0+	USB 2.0 Data Pair Port 0 +	DP-I/O	PD 14.25k to 24.8k in PCH	—
A47	VCC_RTC	Real-Time Clock Circuit Power Input	PWR 3V	—	Voltage range 2.8-3.47V, according to COMe Spec.
A48	RSMRST_OUT#	Module suspend power stable	O-3.3	PD 10k	—

Pin	Signal	Description	Type	Termination	Comment
A49	GBE0_SDP	Gigabit Ethernet Controller 0 Software-Definable Pin	I/O-3.3	PD 10k	—
A50	LPC_SERIRQ/ESPI_CS1#	Serial Interrupt Request / eSPI Master Chip Select 1	IO33-OD	PU 8k2 3.3V (S0)	—
A51	GND	Power Ground	PWR GND	—	—
A52	PCIE_TX5+	PCI Express Lane 5 Transmit +	NC	AC Coupled on Module	Optional if no GbE / with PCIe Switch
A53	PCIE_TX5-	PCI Express Lane 5 Transmit -	NC	AC Coupled on Module	Optional if no GbE / with PCIe Switch
A54	GPI0	General Purpose Input 0	I-3.3	PU 100k 3.3V (S0)	—
A55	PCIE_TX4+	PCI Express Lane 4 Transmit +	DP-O	AC Coupled on Module	—
A56	PCIE_TX4-	PCI Express Lane 4 Transmit -	DP-O	AC Coupled on Module	—
A57	GND	Power Ground	PWR GND	—	—
A58	PCIE_TX3+	PCI Express Lane 3 Transmit +	DP-O	AC Coupled on Module	—
A59	PCIE_TX3-	PCI Express Lane 3 Transmit -	DP-O	AC Coupled on Module	—
A60	GND	Power Ground	PWR GND	—	—
A61	PCIE_TX2+	PCI Express Lane 2 Transmit +	DP-O	AC Coupled on Module	—
A62	PCIE_TX2-	PCI Express Lane 2 Transmit -	DP-O	AC Coupled on Module	—
A63	GPI1	General Purpose Input 1	I-3.3	PU 100k 3.3V (S0)	—
A64	PCIE_TX1+	PCI Express Lane 1 Transmit +	DP-O	AC Coupled on Module	—
A65	PCIE_TX1-	PCI Express Lane 1 Transmit -	DP-O	AC Coupled on Module	—
A66	GND	Power Ground	PWR GND	—	—
A67	GPI2	General Purpose Input 2	I-3.3	PU 100k 3.3V (S0)	—
A68	PCIE_TX0+	PCI Express Lane 0 Transmit +	DP-O	AC Coupled on Module	—
A69	PCIE_TX0-	PCI Express Lane 0 Transmit -	DP-O	AC Coupled on Module	—
A70	GND	Power Ground	PWR GND	—	—
A71	LVDS_A0+	LVDS Channel A DAT0+ / eDP Lane 2 Transmit +	DP-O	—	—
A72	LVDS_A0-	LVDS Channel A DAT0- / eDP Lane 2 Transmit -	DP-O	—	—
A73	LVDS_A1+	LVDS Channel A DAT1+ / eDP Lane 1 Transmit +	DP-O	—	—

Pin	Signal	Description	Type	Termination	Comment
A74	LVDS_A1-	LVDS Channel A DAT1- / eDP Lane 1 Transmit -	DP-O	—	—
A75	LVDS_A2+	LVDS Channel A DAT2+ / eDP Lane 0 Transmit +	DP-O	—	—
A76	LVDS_A2-	LVDS Channel A DAT2- / eDP Lane 0 Transmit -	DP-O	—	—
A77	LVDS_VDD_EN	LVDS / eDP Panel Power Control	O-3.3	PD 100k	—
A78	LVDS_A3+	LVDS Channel A DAT3+	DP-O	—	—
A79	LVDS_A3-	LVDS Channel A DAT3-	DP-O	—	—
A80	GND	Power Ground	PWR GND	—	—
A81	LVDS_A_CK+	LVDS Channel A Clock+ / eDP Lane 3 Transmit +	DP-O	—	Clock: 20-80MHz
A82	LVDS_A_CK-	LVDS Channel A Clock- / eDP Lane 3 Transmit -	DP-O	—	Clock: 20-80MHz
A83	LVDS_I2C_CK	LVDS I2C Clock (DDC) / eDP AUX +	I/O-3.3	PU 2k2 3.3V (S0)	—
A84	LVDS_I2C_DAT	LVDS I2C Data (DDC) / eDP AUX -	I/O-3.3	PU 2k2 3.3V (S0)	—
A85	GPI3	General Purpose Input 3	I-3.3	PU 100k 3.3V (S0)	—
A86	GP_SPI_MOSI	General Purpose SPI Data Out	O-3.3	—	—
A87	eDP_HPDP	eDP Hot Plug Detect	I-3.3	PD 400k LVDS / 100k eDP	—
A88	PCIE_CLK_REF+	Reference PCI Express Clock +	DP-O	—	100MHz
A89	PCIE_CLK_REF-	Reference PCI Express Clock -	DP-O	—	100MHz
A90	GND	Power Ground	PWR GND	—	—
A91	SPI_POWER	3.3V Power Output Pin for external SPI flash	O-3.3	—	100mA (max.)
A92	SPI_MISO	SPI Master In Slave Out	I-3.3	—	—
A93	GPO0	General Purpose Output 0	O-3.3	PD 100k	—
A94	SPI_CLK	SPI Clock	O-3.3	—	—
A95	SPI_MOSI	SPI Master Out Slave In	O-3.3	—	—
A96	TPM_PP	TPM Physical Presence	I-3.3	PD 10k	TPM does not use this functionality
A97	TYPE10#	Indicates TYPE10# to carrier board	NC	—	—
A98	SER0_TX	Serial Port 0 TXD	O-3.3	—	20V protection circuit implemented on module
A99	SER0_RX	Serial Port 0 RXD	I-5T	PU 10k 3.3V (S0)	20V protection circuit implemented on module

Pin	Signal	Description	Type	Termination	Comment
A100	GND	Power Ground	PWR GND	—	—
A101	SER1_TX	Serial Port 1 TXD	O-3.3	—	20V protection circuit implemented on module
A102	SER1_RX	Serial Port 1 RXD	I-5T	PU 10k 3.3V (S0)	20V protection circuit implemented on module
A103	LID#	LID Switch Input	I-3.3	PU 47k 3.3V (S5)	20V protection circuit implemented on module
A104	VCC_12V	Main Input Voltage (8.5-20V)	PWR 8.5-20V	—	—
A105	VCC_12V	Main Input Voltage (8.5-20V)	PWR 8.5-20V	—	—
A106	VCC_12V	Main Input Voltage (8.5-20V)	PWR 8.5-20V	—	—
A107	VCC_12V	Main Input Voltage (8.5-20V)	PWR 8.5-20V	—	—
A108	VCC_12V	Main Input Voltage (8.5-20V)	PWR 8.5-20V	—	—
A109	VCC_12V	Main Input Voltage (8.5-20V)	PWR 8.5-20V	—	—
A110	GND	Power Ground	PWR GND	—	—

Table 39: Connector J1 Pins A1 - A110

4.3.2 Pins B1 - B110

Pin	Signal	Description	Type	Termination	Comment
B1	GND	Power Ground	PWR GND	—	—
B2	GBE0_ACT#	Ethernet Activity LED	OD	—	—
B3	LPC_FRAME#/ESPI_CS0#	LPC Frame Indicator / eSPI Master Chip Select 0	O-3.3	—	—
B4	LPC_AD0/ESPI_IO_0	LPC Multiplexed Command, Address & Data 0 / eSPI Master Data I/O 0	I/O-3.3	PU 20k 3.3V (S0)	—
B5	LPC_AD1/ESPI_IO_1	LPC Multiplexed Command, Address & Data 1 / eSPI Master Data I/O 1	I/O-3.3	PU 20k 3.3V (S0)	—
B6	LPC_AD2/ESPI_IO_2	LPC Multiplexed Command, Address & Data 2 / eSPI Master Data I/O 2	I/O-3.3	PU 20k 3.3V (S0)	—
B7	LPC_AD3/ESPI_IO_3	LPC Multiplexed Command, Address & Data 3 / eSPI Master Data I/O 3	I/O-3.3	PU 20k 3.3V (S0)	—
B8	LPC_DRQ0#/ESPI_ALERT0#	LPC Serial DMA/Master Request 0 / eSPI Alert 0	I-3.3	PU 10k 3.3V (S0)	—
B9	LPC_DRQ1#/ESPI_ALERT1#	LPC Serial DMA/Master Request 1 / eSPI Alert 1	NC	—	10k PU eSPI_noLPC BOM Option
B10	LPC_CLK/ESPI_CK	33MHz LPC Clock	O-3.3	—	33MHz
B11	GND	Power Ground	PWR GND	—	—
B12	PWRBTN#	Power Button	I-3.3	PU 10k 3.3V (S5)	—
B13	SMB_CLK	SMBus Clock	O-3.3	PU 3k9 3.3V (S5)	—
B14	SMB_DAT	SMBus Data	I/O-3.3	PU 3k9 3.3V (S5)	—
B15	SMB_ALERT#	SMBus Alert	O-3.3	PU 10k 3.3V (S5)	—
B16	SATA1_TX+	SATA 1 Transmit Pair +	DP-O	—	—
B17	SATA1_TX-	SATA 1 Transmit Pair -	DP-O	—	—
B18	SUS_STAT#/ESPI_RESET#	Suspend Status / eSPI Reset	O-3.3	PD 10k	—
B19	SATA1_RX+	SATA 1 Receive Pair +	DP-I	—	—
B20	SATA1_RX-	SATA 1 Receive Pair -	DP-I	—	—
B21	GND	Power Ground	PWR GND	—	—
B22	SATA3_TX+	SATA 3 Transmit Pair +	DP-O	—	Optional instead of SATA1

Pin	Signal	Description	Type	Termination	Comment
B23	SATA3_TX-	SATA 3 Transmit Pair -	DP-O	—	Optional instead of SATA1
B24	PWR_OK	Power OK	I-3.3	PU 51k1 3.3V (S5)	20V protection circuit implemented on module
B25	SATA3_RX+	SATA 3 Receive Pair +	DP-I	—	Optional instead of SATA1
B26	SATA3_RX-	SATA 3 Receive Pair -	DP-I	—	Optional instead of SATA1
B27	WDT	Watch Dog Time-Out event	O-3.3	PD 10K	—
B28	HDA_SDIN2/SNDW0_CLK	Not Connected / SoundWire Clock	NC / IO-1.8	—	Not supported / Stuffing option
B29	HDA_SDIN1/SNDW0_DAT	Audio Codec Serial Data In 1 / SoundWire Bidirectional Data	I-3.3 / I/O-1.8	—	— / Stuffing option
B30	HDA_SDIN0	Audio Codec Serial Data In 0	I-3.3	—	—
B31	GND	Power Ground	PWR GND	—	—
B32	SPKR	Speaker	O-3.3	PD 100k	—
B33	I2C_CLK	I2C Clock	O-3.3	PU 2k21 3.3V (S5)	—
B34	I2C_DAT	I2C Data	I/O-3.3	PU 2k21 3.3V (S5)	—
B35	THRM#	Over Temperature Input	I-3.3	PU 10k 3.3V (S0)	—
B36	USB7-	USB 2.0 Data Pair Port 7 -	DP-I/O	PD 14.25k to 24.8k in PCH	—
B37	USB7+	USB 2.0 Data Pair Port 7 +	DP-I/O	PD 14.25k to 24.8k in PCH	—
B38	USB_4_5_OC#	USB Overcurrent Indicator Port 4/5	I-3.3	PU 10k 3.3V (S5)	—
B39	USB5-	USB 2.0 Data Pair Port 5 -	DP-I/O	PD 14.25k to 24.8k in PCH	—
B40	USB5+	USB 2.0 Data Pair Port 5 +	DP-I/O	PD 14.25k to 24.8k in PCH	—
B41	GND	Power Ground	PWR GND	—	—
B42	USB3-	USB 2.0 Data Pair Port 3 -	DP-I/O	PD 14.25k to 24.8k in PCH	—
B43	USB3+	USB 2.0 Data Pair Port 3 +	DP-I/O	PD 14.25k to 24.8k in PCH	—

Pin	Signal	Description	Type	Termination	Comment
B44	USB_0_1_OC#	USB Overcurrent Indicator Port 0/1	I-3.3	PU 10k 3.3V (S5)	—
B45	USB1-	USB 2.0 Data Pair Port 1 -	DP-I/O	PD 14.25k to 24.8k in PCH	—
B46	USB1+	USB 2.0 Data Pair Port 1 +	DP-I/O	PD 14.25k to 24.8k in PCH	—
B47	ESPI_EN#	Enable/Disable ESPI-Mode/LPC-Mode	I-3.3	PU 10k 1.8V (S5)	—
B48	USB0_HOST_PRSENT	Not Connected	NC	PD 10k	—
B49	SYS_RESET#	Reset Button Input	I-3.3	PU 10k 3.3V (S5)	—
B50	CB_RESET#	Carrier Board Reset	O-3.3	PD 10k	—
B51	GND	Power Ground	PWR GND	—	—
B52	PCIE_RX5+	PCI Express Lane 5 Receive +	NC	—	Optional if no GbE / with PCIe Switch
B53	PCIE_RX5-	PCI Express Lane 5 Receive -	NC	—	Optional if no GbE / with PCIe Switch
B54	GPO1	General Purpose Output 1	O-3.3	PD 100k	—
B55	PCIE_RX4+	PCI Express Lane 4 Receive +	DP-I	—	—
B56	PCIE_RX4-	PCI Express Lane 4 Receive -	DP-I	—	—
B57	GPO2	General Purpose Output 2	O-3.3	PD 100k	—
B58	PCIE_RX3+	PCI Express Lane 3 Receive +	DP-I	—	—
B59	PCIE_RX3-	PCI Express Lane 3 Receive -	DP-I	—	—
B60	GND	Power Ground	PWR GND	—	—
B61	PCIE_RX2+	PCI Express Lane 2 Receive +	DP-I	—	—
B62	PCIE_RX2-	PCI Express Lane 2 Receive -	DP-I	—	—
B63	GPO3	General Purpose Output 3	O-3.3	PD 100k	—
B64	PCIE_RX1+	PCI Express Lane 1 Receive +	DP-I	—	—
B65	PCIE_RX1-	PCI Express Lane 1 Receive -	DP-I	—	—
B66	WAKE0#	PCI Express Wake Event	I-3.3	PU 10k 3.3V (S5)	—
B67	WAKE1#	General Purpose Wake Event	I-3.3	PU 10k 3.3V (S5)	—
B68	PCIE_RX0+	PCI Express Lane 0 Receive +	DP-I	—	—

Pin	Signal	Description	Type	Termination	Comment
B69	PCIE_RX0-	PCI Express Lane 0 Receive -	DP-I	—	—
B70	GND	Power Ground	PWR GND	—	—
B71	LVDS_B0+	LVDS Channel B DAT0+	DP-O	—	—
B72	LVDS_B0-	LVDS Channel B DAT0-	DP-O	—	—
B73	LVDS_B1+	LVDS Channel B DAT1+	DP-O	—	—
B74	LVDS_B1-	LVDS Channel B DAT1-	DP-O	—	—
B75	LVDS_B2+	LVDS Channel B DAT2+	DP-O	—	—
B76	LVDS_B2-	LVDS Channel B DAT2-	DP-O	—	—
B77	LVDS_B3+	LVDS Channel B DAT3+	DP-O	—	—
B78	LVDS_B3-	LVDS Channel B DAT3-	DP-O	—	—
B79	LVDS_BKLT_EN	LVDS / eDP Panel Backlight On	O-3.3	PD 100k	—
B80	GND	Power Ground	PWR GND	—	—
B81	LVDS_B_CLK+	LVDS Channel B Clock+	DP-O	—	20-80MHz
B82	LVDS_B_CLK-	LVDS Channel B Clock-	DP-O	—	20-80MHz
B83	LVDS_BKLT_CTRL	LVDS / eDP Backlight Brightness Control	O-3.3	—	—
B84	VCC_5V_SBY	5V Standby	PWR 5V (S5)	—	Optional (not necessary in single supply mode)
B85	VCC_5V_SBY	5V Standby	PWR 5V (S5)	—	Optional (not necessary in single supply mode)
B86	VCC_5V_SBY	5V Standby	PWR 5V (S5)	—	Optional (not necessary in single supply mode)
B87	VCC_5V_SBY	5V Standby	PWR 5V (S5)	—	Optional (not necessary in single supply mode)
B88	BIOS_DIS1#	BIOS Selection Strap 1	I-3.3	PU 10k 3.3V (S5)	—
B89	VGA_RED	CRT_RED / Analog Video RGB-RED	OA	PD 150R	Only with VGA Option
B90	GND	Power Ground	PWR GND	—	—
B91	VGA_GRN	Analog Video RGB-GREEN	OA	PD 150R	Only with VGA Option
B92	VGA_BLU	Analog Video RGB-BLUE	OA	PD 150R	Only with VGA Option
B93	VGA_HSYNC	Analog Video H-Sync	O-3.3	—	Only with VGA Option

Pin	Signal	Description	Type	Termination	Comment
B94	VGA_VSYNC	Analog Video V-Sync	O-3.3	—	Only with VGA Option
B95	VGA_I2C_CK	Display Data Channel Clock	I/O-5	PU 4k7 3.3V (S0)	Only with VGA Option
B96	VGA_I2C_DAT	Display Data Channel Data	I/O-5	PU 4k7 3.3V (S0)	Only with VGA Option
B97	SPI_CS#	SPI Chip Select	O-3.3	PU 10k 3.3V (S5)	—
B98	GP_SPI_MISO	General Purpose SPI Data In	I-3.3	—	—
B99	GP_SPI_CK	General Purpose SPI Clock	O-3.3	—	—
B100	GND	Power Ground	PWR GND	—	—
B101	FAN_PWMOUT	Fan PWM Output	O-3.3	—	20V protection circuit implemented on module, PD on carrier board needed for proper operation
B102	FAN_TACHIN	Fan Tach Input	I-3.3	PU 47k 3.3V (S0)	20V protection circuit implemented on module
B103	SLEEP#	Sleep Button Input	I-3.3	PU 47k 3.3V (S5)	20V protection circuit implemented on module
B104	VCC_12V	Main Input Voltage (8.5-20V)	PWR 8.5-20V	—	—
B105	VCC_12V	Main Input Voltage (8.5-20V)	PWR 8.5-20V	—	—
B106	VCC_12V	Main Input Voltage (8.5-20V)	PWR 8.5-20V	—	—
B107	VCC_12V	Main Input Voltage (8.5-20V)	PWR 8.5-20V	—	—
B108	VCC_12V	Main Input Voltage (8.5-20V)	PWR 8.5-20V	—	—
B109	VCC_12V	Main Input Voltage (8.5-20V)	PWR 8.5-20V	—	—
B110	GND	Power Ground	PWR GND	—	—

Table 40: Connector J1 Pins B1 - B110

4.4 Connector J2 Pinout

4.4.1 Pins C1 - C110

Pin	Signal	Description	Type	Termination	Comment
C1	GND	Power Ground	PWR GND	—	—
C2	GND	Power Ground	PWR GND	—	—
C3	USB_SSRX0-	USB Super Speed Receive 0 -	DP-I	—	—
C4	USB_SSRX0+	USB Super Speed Receive 0 +	DP-I	—	—
C5	GND	Power Ground	PWR GND	—	—
C6	USB_SSRX1-	USB Super Speed Receive 1 -	DP-I	—	—
C7	USB_SSRX1+	USB Super Speed Receive 1 +	DP-I	—	—
C8	GND	Power Ground	PWR GND	—	—
C9	USB_SSRX2-	USB Super Speed Receive 2 -	DP-I	—	—
C10	USB_SSRX2+	USB Super Speed Receive 2 +	DP-I	—	—
C11	GND	Power Ground	PWR GND	—	—
C12	USB_SSRX3-	USB Super Speed Receive 3 -	DP-I	—	—
C13	USB_SSRX3+	USB Super Speed Receive 3 +	DP-I	—	—
C14	GND	Power Ground	PWR GND	—	—
C15	USB4_1_LSTX	USB4 Side-Band TX Interface	O-3.3	—	USB4 not supported by default
C16	USB4_1_LSRX	USB4 Side-Band RX Interface	I-3.3	—	USB4 not supported by default
C17	USB4_RT_ENA	USB4 Retimer Enable	O-3.3	—	USB4 not supported by default
C18	GND	Power Ground	PWR GND	—	—
C19	PCIE_RX6+	PCI Express Lane 6 Receive +	NC	—	Optional if no SATA / with PCIe Switch

Pin	Signal	Description	Type	Termination	Comment
C20	PCIE_RX6-	PCI Express Lane 6 Receive -	NC	—	Optional if no SATA / with PCIe Switch
C21	GND	Power Ground	PWR GND	—	—
C22	PCIE_RX7+	PCI Express Lane 7 Receive +	NC	—	Optional if no SATA / with PCIe Switch
C23	PCIE_RX7-	PCI Express Lane 7 Receive -	NC	—	Optional if no SATA / with PCIe Switch
C24	DDI1_HPD	DDI1 Hotplug Detect	I-3.3	PD 100k	—
C25	SML0_CLK	System Management Link 0 Clock	IO33-OD	PU 3.3V (S5)	USB4 not supported by default
C26	SML0_DAT	System Management Link 0 Data	IO33-OD	PU 3.3V (S5)	USB4 not supported by default
C27	SML1_CLK	System Management Link 1 Clock	IO33-OD	PU 3.3V (S5)	USB4 not supported by default
C28	SML1_DAT	System Management Link 1 Data	IO33-OD	PU 3.3V (S5)	USB4 not supported by default
C29	USB4_PD_I2C_CLK	I2C to USB4 PD Controller Clock	IO33-OD	PU 3.3V (S5)	USB4 not supported by default
C30	USB4_PD_I2C_DAT	I2C to USB4 PD Controller Data	IO33-OD	PU 3.3V (S5)	USB4 not supported by default
C31	GND	Power Ground	PWR GND	—	—
C32	DDI2_CTRLCLK_AUX+/\USB4_2_AUX+	Display Port AUX+ or Display Data Channel Clock	I/O-3.3	PD 100k	USB4 not supported by default
C33	DDI2_CTRLDATA_AUX-/\USB4_2_AUX-	Display Port AUX- or Display Data Channel Data	I/O-3.3	PU 100k 3.3V (S0)	USB4 not supported by default
C34	DDI2_DDC_AUX_SEL	DDI2 DDC/AUX select	I-3.3	PD 1M	—
C35	USB4_2_LSTX	USB4 Side-Band TX interface	O-3.3	—	USB4 not supported by default
C36	DDI3_CTRLCLK_AUX+	DDI3 CTRLCLK/AUX+	I/O-3.3	PD 100k	—
C37	DDI3_CTRLDATA_AUX-	DDI3 CTRLDATA/AUX-	I/O-3.3	PU 100k 3.3V (S0)	—

Pin	Signal	Description	Type	Termination	Comment
C38	DDI3_DDC_AUX_SEL	DDI3 DDC/AUX select	I-3.3	PD 1M	—
C39	DDI3_PAIR0+	DDI3 Pair 0 +	DP-O	—	—
C40	DDI3_PAIR0-	DDI3 Pair 0 -	DP-O	—	—
C41	GND	Power Ground	PWR GND	—	—
C42	DDI3_PAIR1+	DDI3 Pair 1 +	DP-O	—	—
C43	DDI3_PAIR1-	DDI3 Pair 1 -	DP-O	—	—
C44	DDI3_HPD	DDI3 Hotplug Detect	I-3.3	PD 100k	—
C45	GP_SPI_CS#	General Purpose SPI Chip Select	O-3.3	—	—
C46	DDI3_PAIR2+	DDI3 Pair 2 +	DP-O	—	—
C47	DDI3_PAIR2-	DDI3 Pair 2 -	DP-O	—	—
C48	RSVD	Reserved for future use	NC	—	—
C49	DDI3_PAIR3+	DDI3 Pair 3 +	DP-O	—	—
C50	DDI3_PAIR3-	DDI3 Pair 3 -	DP-O	—	—
C51	GND	Power Ground	PWR GND	—	—
C52	PEG_RX0+	PEG Lane 0 Receive +	DP-I	—	—
C53	PEG_RX0-	PEG Lane 0 Receive -	DP-I	—	—
C54	TYPE0#	Not connected for type 6 module	NC	—	—
C55	PEG_RX1+	PEG Lane 1 Receive +	DP-I	—	—
C56	PEG_RX1-	PEG Lane 1 Receive -	DP-I	—	—
C57	TYPE1#	Not connected for type 6 module	NC	—	—
C58	PEG_RX2+	PEG Lane 2 Receive +	DP-I	—	—
C59	PEG_RX2-	PEG Lane 2 Receive -	DP-I	—	—
C60	GND	Power Ground	PWR GND	—	—
C61	PEG_RX3+	PEG Lane 3 Receive +	DP-I	—	—
C62	PEG_RX3-	PEG Lane 3 Receive -	DP-I	—	—
C63	GND	Power Ground	PWR GND	—	—
C64	GND	Power Ground	PWR GND	—	—

Pin	Signal	Description	Type	Termination	Comment
C65	PEG_RX4+	PEG Lane 4 Receive +	DP-I	—	Optionally connected to on-board NVMe
C66	PEG_RX4-	PEG Lane 4 Receive -	DP-I	—	Optionally connected to on-board NVMe
C67	RAPID_SHUTDOWN	Rapid Shutdown Trigger Input	NC	—	—
C68	PEG_RX5+	PEG Lane 5 Receive +	DP-I	—	Optionally connected to on-board NVMe
C69	PEG_RX5-	PEG Lane 5 Receive -	DP-I	—	Optionally connected to on-board NVMe
C70	GND	Power Ground	PWR GND	—	—
C71	PEG_RX6+	PEG Lane 6 Receive +	DP-I	—	Optionally connected to on-board NVMe
C72	PEG_RX6-	PEG Lane 6 Receive -	DP-I	—	Optionally connected to on-board NVMe
C73	GND	Power Ground	PWR GND	—	—
C74	PEG_RX7+	PEG Lane 7 Receive +	DP-I	—	Optionally connected to on-board NVMe
C75	PEG_RX7-	PEG Lane 7 Receive -	DP-I	—	Optionally connected to on-board NVMe
C76	GND	Power Ground	PWR GND	—	—
C77	GND	Power Ground	PWR GND	—	—
C78	PEG_RX8+	PEG Lane 8 Receive +	DP-I	—	Only on H-series SKUs
C79	PEG_RX8-	PEG Lane 8 Receive -	DP-I	—	Only on H-series SKUs
C80	GND	Power Ground	PWR GND	—	—
C81	PEG_RX9+	PEG Lane 9 Receive +	DP-I	—	Only on H-series SKUs

Pin	Signal	Description	Type	Termination	Comment
C82	PEG_RX9-	PEG Lane 9 Receive -	DP-I	—	Only on H-series SKUs
C83	GND	Power Ground	PWR GND	—	—
C84	GND	Power Ground	PWR GND	—	—
C85	PEG_RX10+	PEG Lane 10 Receive +	DP-I	—	Only on H-series SKUs
C86	PEG_RX10-	PEG Lane 10 Receive -	DP-I	—	Only on H-series SKUs
C87	GND	Power Ground	PWR GND	—	—
C88	PEG_RX11+	PEG Lane 11 Receive +	DP-I	—	Only on H-series SKUs
C89	PEG_RX11-	PEG Lane 11 Receive -	DP-I	—	Only on H-series SKUs
C90	GND	Power Ground	PWR GND	—	—
C91	PEG_RX12+	PEG Lane 12 Receive +	DP-I	—	Only on H-series SKUs
C92	PEG_RX12-	PEG Lane 12 Receive -	DP-I	—	Only on H-series SKUs
C93	GND	Power Ground	PWR GND	—	—
C94	PEG_RX13+	PEG Lane 13 Receive +	DP-I	—	Only on H-series SKUs
C95	PEG_RX13-	PEG Lane 13 Receive -	DP-I	—	Only on H-series SKUs
C96	GND	Power Ground	PWR GND	—	—
C97	GND	Power Ground	PWR GND	—	—
C98	PEG_RX14+	PEG Lane 14 Receive +	DP-I	—	Only on H-series SKUs
C99	PEG_RX14-	PEG Lane 14 Receive -	DP-I	—	Only on H-series SKUs
C100	GND	Power Ground	PWR GND	—	—
C101	PEG_RX15+	PEG Lane 15 Receive +	DP-I	—	Only on H-series SKUs
C102	PEG_RX15-	PEG Lane 15 Receive -	DP-I	—	Only on H-series SKUs
C103	GND	Power Ground	PWR GND	—	—
C104	VCC_12V	Main Input Voltage (8.5-20V)	PWR 8.5-20V	—	—
C105	VCC_12V	Main Input Voltage (8.5-20V)	PWR 8.5-20V	—	—
C106	VCC_12V	Main Input Voltage (8.5-20V)	PWR 8.5-20V	—	—

Pin	Signal	Description	Type	Termination	Comment
C107	VCC_12V	Main Input Voltage (8.5-20V)	PWR 8.5-20V	—	—
C108	VCC_12V	Main Input Voltage (8.5-20V)	PWR 8.5-20V	—	—
C109	VCC_12V	Main Input Voltage (8.5-20V)	PWR 8.5-20V	—	—
C110	GND	Power Ground	PWR GND	—	—

Table 41: Connector J2 Pins C1 - C110

4.4.2 Pins D1 - D110

Pin	Signal	Description	Type	Termination	Comment
D1	GND	Power Ground	PWR GND	—	—
D2	GND	Power Ground	PWR GND	—	—
D3	USB_SSTX0-	USB Super Speed Transmit 0 -	DP-O	—	—
D4	USB_SSTX0+	USB Super Speed Transmit 0 +	DP-O	—	—
D5	GND	Power Ground	PWR GND	—	—
D6	USB_SSTX1-	USB Super Speed Transmit 1 -	DP-O	—	—
D7	USB_SSTX1+	USB Super Speed Transmit 1 +	DP-O	—	—
D8	GND	Power Ground	PWR GND	—	—
D9	USB_SSTX2-	USB Super Speed Transmit 2 -	DP-O	—	—
D10	USB_SSTX2+	USB Super Speed Transmit 2 +	DP-O	—	—
D11	GND	Power Ground	PWR GND	—	—
D12	USB_SSTX3-	USB Super Speed Transmit 3 -	DP-O	—	—
D13	USB_SSTX3+	USB Super Speed Transmit 3 +	DP-O	—	—
D14	GND	Power Ground	PWR GND	—	—
D15	DDI1_CTRLCLK_AUX+/\USB4_1_AUX+	Display Port AUX+ or Display Data Channel Clock	I/O-3.3	PD 100k	USB4 not supported by default
D16	DDI1_CTRLDATA_AUX-/\USB4_1_AUX-	Display Port AUX- or Display Data Channel Data	I/O-3.3	PU 100k 3.3V (S0)	USB4 not supported by default
D17	USB4_PD_I2C_ALERT#	I2C Alert from PD Controller	I-3.3	—	USB4 not supported by default
D18	PMCALERT#	Alert from Carrier PD Controller (associated with SML1)	I-3.3	10K PU (S5)	USB4 not supported by default
D19	PCIE_TX6+	PCI Express Lane 6 Transmit +	NC	AC Coupled on Module	Optional if no SATA / with PCIe Switch

Pin	Signal	Description	Type	Termination	Comment
D20	PCIE_TX6-	PCI Express Lane 6 Transmit -	NC	AC Coupled on Module	Optional if no SATA / with PCIe Switch
D21	GND	Power Ground	PWR GND	—	—
D22	PCIE_TX7+	PCI Express Lane 7 Transmit +	NC	AC Coupled on Module	Optional if no SATA / with PCIe Switch
D23	PCIE_TX7-	PCI Express Lane 7 Transmit -	NC	AC Coupled on Module	Optional if no SATA / with PCIe Switch
D24	GND	Power Ground	PWR GND	—	—
D25	GND	Power Ground	PWR GND	—	—
D26	DDI1_PAIR0+/\USB4_1_SSTX0+	DDI1 Pair 0 + / USB4 1 Data Transmit Pair 0	DP-O	—	USB4 not supported by default
D27	DDI1_PAIR0-/\USB4_1_SSTX0-	DDI1 Pair 0 - / USB4 1 Data Transmit Pair 0	DP-O	—	USB4 not supported by default
D28	GND	Power Ground	PWR GND	—	—
D29	DDI1_PAIR1+/\USB4_1_SSRX0+	DDI1 Pair 1 + / USB4 1 Data Receive Pair 0	DP-I/O	—	USB4 not supported by default
D30	DDI1_PAIR1-/\USB4_1_SSRX0-	DDI1 Pair 1 - / USB4 1 Data Receive Pair 0	DP-I/O	—	USB4 not supported by default
D31	GND	Power Ground	PWR GND	—	—
D32	DDI1_PAIR2+/\USB4_1_SSTX1+	DDI1 Pair 2 + / USB4 1 Data Transmit Pair 1	DP-O	—	USB4 not supported by default
D33	DDI1_PAIR2-/\USB4_1_SSTX1-	DDI1 Pair 2 - / USB4 1 Data Transmit Pair 1	DP-O	—	USB4 not supported by default
D34	DDI1_DDC_AUX_SEL	DDI1 DDC/AUX select	I-3.3	PD 1M	—
D35	USB4_2_LSRX	USB4 Side-Band RX Interface	I-3.3	—	USB4 not supported by default
D36	DDI1_PAIR3+/\USB4_1_SSRX1+	DDI1 Pair 3 + / USB4 1 Data Receive Pair 1	DP-I/O	—	USB4 not supported by default
D37	DDI1_PAIR3-/\USB4_1_SSRX1-	DDI1 Pair 3 - / USB4 1 Data Receive Pair 1	DP-I/O	—	USB4 not supported by default
D38	GND	Power Ground	PWR GND	—	—

Pin	Signal	Description	Type	Termination	Comment
D39	DDI2_PAIR0+/\USB4_2_SSTX0+	DDI2 Pair 0 + / USB4 2 Data Transmit Pair 0	DP-O	—	USB4 not supported by default
D40	DDI2_PAIR0-/\USB4_2_SSTX0-	DDI2 Pair 0 - / USB4 2 Data Transmit Pair 0	DP-O	—	USB4 not supported by default
D41	GND	Power Ground	PWR GND	—	—
D42	DDI2_PAIR1+/\USB4_2_SSRX0+	DDI2 Pair 1 + / USB4 2 Data Receive Pair 0	DP-I/O	—	USB4 not supported by default
D43	DDI2_PAIR1-/\USB4_2_SSRX0-	DDI2 Pair 1 - / USB4 2 Data Receive Pair 0	DP-I/O	—	USB4 not supported by default
D44	DDI2_HPD	DDI2 Hotplug Detect	I-3.3	PD 100k	—
D45	GND	Power Ground	PWR GND	—	—
D46	DDI2_PAIR2+/\USB4_2_SSTX1+	DDI2 Pair 2 + / USB4 2 Data Transmit Pair 1	DP-O	AC Coupled on Module	USB4 not supported by default
D47	DDI2_PAIR2-/\USB4_2_SSTX1-	DDI2 Pair 2 - / USB4 2 Data Transmit Pair 1	DP-O	AC Coupled on Module	USB4 not supported by default
D48	GND	Power Ground	PWR GND	—	—
D49	DDI2_PAIR3+/\USB4_2_SSRX1+	DDI2 Pair 3 + / USB4 2 Data Receive Pair 1	DP-I/O	—	USB4 not supported by default
D50	DDI2_PAIR3-/\USB4_2_SSRX1-	DDI2 Pair 3 - / USB4 2 Data Receive Pair 1	DP-I/O	—	USB4 not supported by default
D51	GND	Power Ground	PWR GND	—	—
D52	PEG_TX0+	PEG Lane 0 Transmit +	DP-O	—	—
D53	PEG_TX0-	PEG Lane 0 Transmit -	DP-O	—	—
D54	PEG_LANE_RV#	PEG Lane Reversal input strap	I-3.3	PU 10K 3.3V (S0)	Pull low on the carrier board to reverse lane order
D55	PEG_TX1+	PEG Lane 1 Transmit +	DP-O	—	—
D56	PEG_TX1-	PEG Lane 1 Transmit -	DP-O	—	—
D57	TYPE2#	GND for type 6 module	PWR	—	—
D58	PEG_TX2+	PEG Lane 2 Transmit +	DP-O	—	—

Pin	Signal	Description	Type	Termination	Comment
D59	PEG_TX2-	PEG Lane 2 Transmit -	DP-O	—	—
D60	GND	Power Ground	PWR GND	—	—
D61	PEG_TX3+	PEG Lane 3 Transmit +	DP-O	—	—
D62	PEG_TX3-	PEG Lane 3 Transmit -	DP-O	—	—
D63	GND	Power Ground	PWR GND	—	—
D64	GND	Power Ground	PWR GND	—	—
D65	PEG_TX4+	PEG Lane 4 Transmit +	DP-O	—	Optionally connected to on-board NVME
D66	PEG_TX4-	PEG Lane 4 Transmit -	DP-O	—	Optionally connected to on-board NVME
D67	GND	Power Ground	PWR GND	—	—
D68	PEG_TX5+	PEG Lane 5 Transmit +	DP-O	—	Optionally connected to on-board NVME
D69	PEG_TX5-	PEG Lane 5 Transmit -	DP-O	—	Optionally connected to on-board NVME
D70	GND	Power Ground	PWR GND	—	—
D71	PEG_TX6+	PEG Lane 6 Transmit +	DP-O	—	Optionally connected to on-board NVME
D72	PEG_TX6-	PEG Lane 6 Transmit -	DP-O	—	Optionally connected to on-board NVME
D73	GND	Power Ground	PWR GND	—	—
D74	PEG_TX7+	PEG Lane 7 Transmit +	DP-O	—	Optionally connected to on-board NVME
D75	PEG_TX7-	PEG Lane 7 Transmit -	DP-O	—	Optionally connected to on-board NVME

Pin	Signal	Description	Type	Termination	Comment
D76	GND	Power Ground	PWR GND	—	—
D77	GND	Power Ground	PWR GND	—	—
D78	PEG_TX8+	PEG Lane 8 Transmit +	DP-O	—	Only on H-series SKUs
D79	PEG_TX8-	PEG Lane 8 Transmit -	DP-O	—	Only on H-series SKUs
D80	GND	Power Ground	PWR GND	—	—
D81	PEG_TX9+	PEG Lane 9 Transmit +	DP-O	—	Only on H-series SKUs
D82	PEG_TX9-	PEG Lane 9 Transmit -	DP-O	—	Only on H-series SKUs
D83	GND	Power Ground	PWR GND	—	—
D84	GND	Power Ground	PWR GND	—	—
D85	PEG_TX10+	PEG Lane 10 Transmit +	DP-O	—	Only on H-series SKUs
D86	PEG_TX10-	PEG Lane 10 Transmit -	DP-O	—	Only on H-series SKUs
D87	GND	Power Ground	PWR GND	—	—
D88	PEG_TX11+	PEG Lane 11 Transmit +	DP-O	—	Only on H-series SKUs
D89	PEG_TX11-	PEG Lane 11 Transmit -	DP-O	—	Only on H-series SKUs
D90	GND	Power Ground	PWR GND	—	—
D91	PEG_TX12+	PEG Lane 12 Transmit +	DP-O	—	Only on H-series SKUs
D92	PEG_TX12-	PEG Lane 12 Transmit -	DP-O	—	Only on H-series SKUs
D93	GND	Power Ground	PWR GND	—	—
D94	PEG_TX13+	PEG Lane 13 Transmit +	DP-O	—	Only on H-series SKUs
D95	PEG_TX13-	PEG Lane 13 Transmit -	DP-O	—	Only on H-series SKUs
D96	GND	Power Ground	PWR GND	—	—
D97	GND	Power Ground	PWR GND	—	—
D98	PEG_TX14+	PEG Lane 14 Transmit +	DP-O	—	Only on H-series SKUs
D99	PEG_TX14-	PEG Lane 14 Transmit -	DP-O	—	Only on H-series SKUs
D100	GND	Power Ground	PWR GND	—	—

Pin	Signal	Description	Type	Termination	Comment
D101	PEG_TX15+	PEG Lane 15 Transmit +	DP-O	—	Only on H-series SKUs
D102	PEG_TX15-	PEG Lane 15 Transmit -	DP-O	—	Only on H-series SKUs
D103	GND	Power Ground	PWR GND	—	—
D104	VCC_12V	Main Input Voltage (8.5-20V)	PWR 8.5-20V	—	—
D105	VCC_12V	Main Input Voltage (8.5-20V)	PWR 8.5-20V	—	—
D106	VCC_12V	Main Input Voltage (8.5-20V)	PWR 8.5-20V	—	—
D107	VCC_12V	Main Input Voltage (8.5-20V)	PWR 8.5-20V	—	—
D108	VCC_12V	Main Input Voltage (8.5-20V)	PWR 8.5-20V	—	—
D109	VCC_12V	Main Input Voltage (8.5-20V)	PWR 8.5-20V	—	—
D110	GND	Power Ground	PWR GND	—	—

Table 42: Connector J2 Pins D1 - D110

5. UEFI BIOS

5.1 Starting the UEFI BIOS

The COMe-bRP6 uses a Kontron-customized, pre-installed and configured version of AMI Aptio® V BIOS based on the Unified Extensible Firmware Interface (UEFI) specification and the Intel® Platform Innovation Framework for EFI.

The UEFI BIOS provides a variety of new and enhanced functions specifically tailored to the hardware features of the COMe-bRP6.



This chapter provides an overview of the BIOS and its setup. A more detailed listing and description of all BIOS setup nodes can be found in the BIOS file package available on our [Customer Section](#). Please register there to get access to BIOS downloads and Product Change Notifications.

The UEFI BIOS comes with a Setup program that provides quick and easy access to the individual function settings for control or modification of the default configuration. The Setup program allows access to various menus resp. sub-menus that provide the specific functions.

To start the UEFI BIOS Setup program, follow the steps below:

1. Power on the board
2. Wait until the first characters appear on the screen (POST messages or splash screen)
3. Press the key
4. If the UEFI BIOS is password-protected, a request for password will appear. Enter either the User Password or the Supervisor Password
5. The Setup menu appears

5.2 Navigating the UEFI BIOS

The COMe-bRP6 UEFI BIOS Setup program uses a hot key navigation system with a corresponding legend bar displayed on the setup screens. The following table provides a list of navigation hot keys available in the legend bar.

Hot Key	Description
<F1>	<F1> key invokes the General Help window
↔	<Minus> key selects the next lower value within a field
<+>	<Plus> key selects the next higher value within a field
<F2>	<F2> key loads previous values
<F3>	<F3> key loads optimized defaults
<F4>	<F4> key Saves and Exits
<←> or <→>	<Left/Right> arrows select major Setup menus on menu bar, for example, Main or Advanced
<↑> or <↓>	<Up/Down> arrows select fields in the current menu, for example, Setup function or sub-screen
<ESC>	<ESC> key exits a major Setup menu and enters the Exit Setup menu. Pressing the <ESC> key in a sub-menu displays the next higher menu level
<RETURN>	<RETURN> key executes a command or selects a sub-menu

Table 43: Navigation Hot Keys Available in the Legend Bar

5.3 Setup Menus

The Setup utility features a selection bar at the top of the screen that lists the menus



Figure 10: Setup Menu Selection Bar

The Setup menus available for the COMe-bRP6 are:

- Main
- Advanced
- Chipset
- Security
- Boot
- Save & Exit

The currently active menu is highlighted in grey, the currently active UEFI BIOS Setup item in white. Use the left and right arrow keys to select the Setup menu.

Each Setup menu provides two main frames. The left frame displays all available functions and configurable ones are displayed in blue. Functions displayed in grey provide information about the status or the operational configuration.

5.4 Getting Help

The right frame displays a help window. The help window provides an explanation of the respective function.

5.5 UEFI Shell

The Kontron UEFI BIOS features a built-in and enhanced version of the UEFI Shell. For a detailed description of the available standard shell scripting, refer to the EFI Shell User Guide. For a detailed description of the available standard shell commands, refer to the EFI Shell Command Manual. Both documents can be downloaded from the EFI and Framework Open Source Community homepage: <http://sourceforge.net/projects/efi-shell/files/documents/>.



Kontron UEFI BIOS does not provide all shell commands described in the EFI Shell Command Manual.

5.5.1 Entering the UEFI Shell

To enter the UEFI Shell, follow the steps below:

1. Power on the board
2. Press the <F7> key (instead of) to display a choice of boot devices
3. Select 'UEFI: Built-in EFI shell'

```
UEFI Interactive Shell v2.2
EDK II / Kontron add-on v0.3
UEFI v2.80 (American Megatrends, 0x0005001A)
map: No mapping found.
```

1. Press the <ESC> key within 5 seconds to skip startup.nsh or any other key to continue
2. The output produced by the device-mapping table can vary depending on the board's configuration
3. If the <ESC> key is pressed before the 5 second timeout elapses, the shell prompt is shown:

```
Shell>
```

5.5.2 Exiting the UEFI Shell

To exit the UEFI Shell, follow one of the steps below:

- Use the **exit** UEFI Shell command to select the boot device, in the Boot menu, that the OS boots from
- Reset the board using the **reset** UEFI Shell command
- Press the reset button of the board or power down/up the board

5.6 UEFI Shell Scripting

5.6.1 Startup Scripting

If the <ESC> key is not pressed and the timeout has run out, then the UEFI Shell automatically tries to execute some startup scripts. The UEFI shell searches for scripts and executes them in the following order:

1. Initially searches for Kontron flash-stored startup script
2. If there is no Kontron flash-stored startup script present, then the UEFI-specified **startup.nsh** script is used. This script must be located on the root of any of the attached FAT-formatted disk drives
3. If none of the startup scripts are present or the startup script terminates then the default boot order is continued

5.6.2 Create a Startup Script

Startup scripts can be created using the UEFI Shell built-in editor **edit** or under any OS with a plain text editor of your choice.

5.6.3 Example of Startup Scripts

Execute Shell Script on other Harddrive

This example (**startup.nsh**) executes the shell script named **bootme.nsh** located in the root of the first detected disk drive (**fs0**).

```
fs0:  
bootme.nsh
```

5.7 Firmware Update

Firmware updates are typically delivered as a ZIP archive. Please find the latest available BIOS-ZIP archive on [Kontron's Customer Section](#). Further information about the firmware update procedure can be found in the included "flash_instruction.txt"-file.



Register to [Kontron's Customer Section](#) to get access to BIOS downloads, additional documentation and Product Change Notification service.

6. Technical Support

For technical support contact our Support Department:

E-Mail:	support@kontron.com
Phone:	+49 (0) 821 4086-888

Make sure you have the following information available when you call:

- Product ID Number (PN)
- Serial Number (SN)
- Module's revision
- Operating System and Kernel/Build version
- Software modifications
- Additional connected hardware/full description of hardware set up



The Serial Number can be found on the Type Label, located on the product.

Be ready to explain the nature of your problem to the service technician.

6.1 Warranty

Due to their limited service life, parts that by their nature are subject to a particularly high degree of wear (wearing parts) are excluded from the warranty beyond that provided by law.



If there is a protection label on your product, then the warranty is lost if the product is opened.

6.2 Returning Defective Material

All equipment returned to Kontron must have a Return of Material Authorization (RMA) number assigned exclusively by Kontron. Kontron cannot be held responsible for any loss or damage caused to the equipment received without an RMA number. The buyer accepts responsibility for all freight charges for the return of goods to Kontron's designated facility. Kontron will pay the return freight charges back to the buyer's location in the event that the equipment is repaired or replaced within the stipulated warranty period. Follow these steps before returning any product to Kontron:

1. Visit the RMA Information website: [RMA Information - Kontron Europe and Asia](#)

2. Download the RMA Request sheet for **Kontron Europe GmbH** and fill out the form. Take care to include a short detailed description of the observed problem or failure and to include the product identification information (Name of product, Product Number and Serial Number). If a delivery includes more than one product, fill out the above information in the RMA Request form for each product.
3. Send the completed RMA-Request form to the fax or email address given below at Kontron Europe GmbH.
Kontron will provide an RMA-Number.

Kontron Europe GmbH
RMA Support
Phone: +49 (0) 821 4086-0
Fax: +49 (0) 821 4086-111
Email: service@kontron.com

4. The goods for repair must be packed properly for shipping, considering shock and ESD protection.



Goods returned to Kontron Europe GmbH in non-proper packaging will be considered as customer caused faults and cannot be accepted as warranty repairs.

5. Include the RMA-Number with the shipping paperwork and send the product to the delivery address provided in the RMA form or received from Kontron RMA Support.

7. Document Revision

The following table shows the revision of this document.

Revision	Author	Date	Comment
0.1	ZEV	2023-11-30	Initial preliminary release
1.0	ZEV	2024-01-02	Added MTBF value; Document release

Table 44: Document Revision Table