

» User's Guide «



KISS 1U Short

User's Guide (Version V1.10)

0-0096-4515

This page is intentionally left blank.

1. Table of Contents

1. Table of Contents	1
1.1. Table of Figures	2
2. Introduction	4
2.1. Symbols used in this Manual	5
3. Important Instructions	6
3.1. Note on the Warranty	6
3.2. Exclusion of Accident Liability Obligation	6
3.3. Liability Limitation / Exemption from the Warranty Obligation	6
4. General Safety Instructions for IT Equipment	7
4.1. Operation of Laser Source Devices	7
4.2. Electrostatic Discharge (ESD)	8
4.2.1. Grounding Methods.....	8
4.3. Instructions for the Lithium Battery.....	8
5. Electromagnetic Compatibility (Class A Device)	9
5.1. Electromagnetic Compatibility (EU)	9
5.2. FCC Statement (USA).....	9
5.3. EMC Compliance (Canada)	9
6. Scope of Delivery	10
6.1. Type Label and Product Identification	10
7. Product Description	11
7.1. Front Side	13
7.1.1. Interfaces on the Front Side.....	14
7.1.2. Controls and LED Indicators	14
7.1.3. Filter Mat Holder.....	14
7.1.4. External Accessible Drive Bays	14
7.2. Rear Side	15
7.2.1. Interfaces of the Motherboard on the Rear Side	15
7.2.2. Power Supply Unit.....	15
7.3. Side View	16
7.4. Cover	16
7.4.1. Fan Modules	17
8. Assembly, Disassembly	18
8.1. Attaching the Rubber Feet	18
8.2. Accessing Internal Components	18
8.2.1. Installing/Removing the Expansion Cards	18
8.3. Instruction for Installation in a 19” Cabinet	21
9. Starting Up	22
9.1. AC-Power Cord Connection	22
9.2. Operating System and Hardware Components Drivers	23
10. Maintenance and Prevention	24
10.1. Replacing the Lithium Battery.....	24
10.2. Replacing the System’s Fans	24

10.3. Cleaning the Filter Mat	25
11. Slide Rails (Option)	27
11.1.1. Slide Rails Accessories and Assembling	28
12. Main Specifications	29
12.1. Electrical Specifications	29
12.2. Mechanical Specifications	30
12.3. Environmental Specifications	30
12.4. CE Directives and Standards	31
13. Standard Interfaces – Pin Assignments	32
13.1.1. Serial Interface COM (RS232)	32
13.1.2. VGA Port	32
13.1.3. PS/2 Mouse Connector.....	33
13.1.4. PS/2 Keyboard Connector	33
13.1.5. USB Port	33
13.1.6. USB Port (3.0)	34
13.1.7. DVI-I (Single Link) Interface.....	34
14. Technical Support	35
14.1. Returning Defective Merchandise	35

1.1. Table of Figures

Fig. 1: Laser radiation warning label	7
Fig. 2: Rackmount version with closed access door	11
Fig. 3: Desktop version with closed access door.....	11
Fig. 4: KISS 1U Short platform	11
Fig. 5: KISS 1U Short platform, rackmount version, opened	12
Fig. 6: Front side (rackmount version) with closed front access door	13
Fig. 7: 19" rack mountable bracket with fastening screws	13
Fig. 8: Front side (rackmount version) with opened front access door	13
Fig. 9: Power button and LED indicators	14
Fig. 10: Rear side of the KISS 1U Short with KTGM45/mITX motherboard.....	15
Fig. 11: Rear side of the KISS 1U Short with KTQM77/mITX motherboard.....	15
Fig. 12: Side view with tapped M4 metric holes to attach a telescope rail	16
Fig. 13: Inside of the cover with fixing brackets	16
Fig. 14: Fan modules	17
Fig. 15: Loosening the three fastening screws on the rear side of the KISS 1U Short system.....	18
Fig. 16: Sliding the cover back will pull out the cover fixing brackets from the retaining brackets of the chassis	19
Fig. 17: Removing the cover	19
Fig. 18: Detail: Rear side with slide bracket closed (for fixing the expansion cards/slot brackets)	19

Fig. 19: Detail: Rear side with slide bracket(opened)	19
Fig. 20: Detail with opened slide brackets for 2x PCI-card slots (Config. with KTGM45)	20
Fig. 21: Detail closed slide brackets, 1x PCIe x16-card slot (Config. with KTQM77)	20
Fig. 22: KISS 1U Short (shown as system with AC-power connection)	22
Fig. 23: Detail of the front side - Location of the filter mat.....	25
Fig. 24: Detail: front side without filter mat and filter mat holder.....	25
Fig. 25: Filter mat	25
Fig. 26: Filter mat holder	25
Fig. 27: Attaching the inner side of the slide rail.....	27
Fig. 28: KISS 1U Short with slide rails in pulled-out position	27
Fig. 29: KISS 1U Short with slide rails	27
Fig. 30: Assembling the “Telescopic Rail” set	28

2. Introduction

Kontron Europe GmbH would like to point out that the information contained in this manual may be subject to technical alteration, particularly as a result of the constant upgrading of Kontron Europe products. The attached documentation does not entail any guarantee on the part of Kontron Europe with respect to technical processes described in the manual or any product characteristics set out in the manual. Kontron Europe does not accept any liability for any printing errors or other inaccuracies in the manual unless it can be proven that Kontron Europe is aware of such errors or inaccuracies or that Kontron Europe is unaware of these as a result of gross negligence and Kontron Europe has failed to eliminate these errors or inaccuracies for this reason. Kontron Europe expressly informs the user that this manual only contains a general description of technical processes and instructions which may not be applicable in every individual case. In cases of doubt, please contact Kontron Europe.





This manual is protected by copyright. All rights are reserved by Kontron Europe. Copies of all or part of this manual or translations into a different language may only be made with the prior written consent of Kontron Europe. Kontron Europe points out that the information contained in this manual is constantly being updated in line with the technical alterations and improvements made by Kontron Europe to the products and thus this manual only reflects the technical status of the products by Kontron Europe at the time of printing.

© 2014 by Kontron Europe GmbH

Printing and duplication, even of sections, is only permissible with the express approval of

Kontron Europe GmbH
Site Eching
Oskar-von-Miller-Str. 1
85386 Eching
Germany

2.1. Symbols used in this Manual

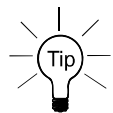
Symbol	Meaning
	This symbol indicates the danger of injury to the user or the risk of damage to the product if the corresponding warning notices are not observed.
	This symbol indicates that the product or parts thereof may be damaged if the corresponding warning notices are not observed.
	This symbol indicates general information about the product and the user manual.
	This symbol indicates detail information about the specific product configuration.
	This symbol precedes helpful hints and tips for daily use.

3. Important Instructions

This chapter contains instructions which must be observed when using your KISS 1U Short platform.

The manufacturer's instructions provide useful information on your KISS 1U Short platform.

3.1. Note on the Warranty

Due to their limited service life, parts which by their nature are subject to a particularly high degree of wear (wearing parts) are excluded from the warranty beyond that provided by law. This applies to batteries, for example.

3.2. Exclusion of Accident Liability Obligation

Kontron Embedded Computers shall be exempted from the statutory accident liability obligation if the user fails to observe the included document: "General Safety Instructions for IT Equipment" the hints in this manual or eventually the warning signs label on the device.

3.3. Liability Limitation / Exemption from the Warranty Obligation

In the event of damage to the device caused by failure to observe the included document "General Safety Instructions for IT Equipment", the hints in this manual or eventually the warning signs label on the device, Kontron Embedded Computers shall not be required to honor the warranty even during the warranty period and shall be exempted from the statutory accident liability obligation.

4. General Safety Instructions for IT Equipment



Please consider the included "General Safety Instructions for IT Equipment".

4.1. Operation of Laser Source Devices

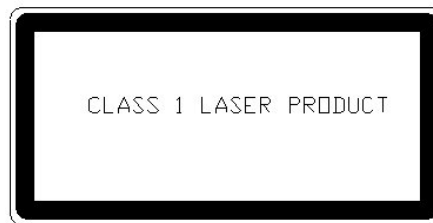

Fig. 1: Laser radiation warning label

The optional DVD drive contain light-emitting diodes (classified in accordance with IEC 60825-1:2007: LASER CLASS 1) and therefore must not be opened.

If the enclosure of such a drive is opened, invisible laser radiation is emitted. Do not allow yourself to be exposed to this radiation.

The laser system meets the code of Federal Regulations 21 CFR, 1040 for the USA and the Canadian Radiation Emitting Devices Act, REDR C 1370.



4.2. Electrostatic Discharge (ESD)

A sudden discharge of electrostatic electricity can destroy static-sensitive devices or micro-circuitry. Therefore proper packaging and grounding techniques are necessary precautions to prevent damage. Always take the following precautions:

1. Transport boards in ESD-safe containers such as boxes or bags.
2. Keep electrostatic sensitive parts in their containers until they arrive at the ESD-safe workplace.
3. Always be properly grounded when touching a sensitive board, component, or assembly.
4. Store electrostatic-sensitive boards in protective packaging or on antistatic mats.

4.2.1. Grounding Methods

The following measures help to avoid electrostatic damages to the device:

1. Cover workstations with approved antistatic material. Always wear a wrist strap connected to workplace as well as properly grounded tools and equipment.
2. Use antistatic mats, heel straps, or air ionizers for more protection.
3. Always handle electrostatically sensitive components by their edge or by their casing.
4. Avoid contact with pins, leads, or circuitry.
5. Turn off power and input signals before inserting and removing connectors or connecting test equipment.
6. Keep work area free of non-conductive materials such as ordinary plastic assembly aids and styrofoam.
7. Use field service tools such as cutters, screwdrivers, and vacuum cleaners which are conductive.
8. Always place drives and boards PCB-assembly-side down on the foam.

4.3. Instructions for the Lithium Battery

The implemented motherboard or SBC-board is equipped with a Lithium battery. For the replacing of this battery please observe the instructions described in the chapter "Replacing the Lithium Battery".



Caution

Danger of explosion when replacing with wrong type of battery. Replace only with the same or equivalent type recommended by the manufacturer. The lithium battery type must be UL recognized.



Do not dispose of lithium batteries in general trash collection. Dispose of the battery according to the local regulations dealing with the disposal of these special materials, (e.g. to the collecting points for dispose of batteries).

5. Electromagnetic Compatibility (Class A Device)

5.1. Electromagnetic Compatibility (EU)

This product is intended only for use in industrial areas. The most recent version of the EMC guidelines (EMC Directive 2004/108/EC) and/or the German EMC laws apply. If the user modifies and/or adds to the equipment (e.g. installation of add-on cards) the prerequisites for the CE conformity declaration (safety requirements) may no longer apply.

Warning!

This is a class A product. In domestic environment this product may cause radio interference in which case the user may be required to take adequate measures.

5.2. FCC Statement (USA)

This equipment has been tested and found to comply with the limits for a Class A digital device, pursuant to Part 15 of the FCC Rules. These limits are designed to provide reasonable protection against harmful interference when the equipment is operated in commercial environment. This equipment generates, uses, and can radiate radio frequency energy and, if not installed and used in accordance with the instruction manual, may cause harmful interference to radio communications. Operation of this equipment in residential area is likely to cause harmful interference in which case the user will be required to correct the interference at his own expense.

5.3. EMC Compliance (Canada)

The method of compliance is self-declaration to Canadian standard ICES-003:

(English): This Class A digital apparatus complies with the Canadian ICES-003.

(French): Cet appareil numérique de la class A est conforme à la norme NMB-003 du Canada.

6. Scope of Delivery

- KISS 1U Short platform (configured as ordered)
- Power cord (for AC power supply units only)
- General Safety Instruction for IT Equipment
- Rubber feet (self-adhesive)

Optional Parts

- Slide rails

6.1. Type Label and Product Identification

The type label (Product Designation, Serial Number) and the inspection status label of the KISS 1U Short platform is placed on the right side of the unit.

System Type	Product Designation	Product Identification
KISS 1U Short	KISS 1U short xxxxxxxx-y	<p>KISS 1U short = System type</p> <p>The "xxxxxxx"-Group is replaced by numbers (100 through 999), representing the installed CPU board.</p> <p>"y" is replaced by a single letter (A through Z) representing the power supply installed in the system.</p>

Note for the equipped PSU (Power Supply Unit):

A: corresponds to the systems with a wide range AC power supply (100-240 V, 270 W)

7. Product Description

KISS 1U Short extends the range of Kontron's product family– KISS -. It is a 1U (19") platform equipped with a motherboard and can be equipped with up to three drive bays (refer to the "Configuration Guide" on our web site). The flexible hardware system configuration and robust design with excellent mechanical stability provides the KISS 1U Short platform with the necessary characteristics for a computer, which is suitable for use in harsh industrial environments.

The KISS 1U Short platform is designed to be installed in 19" racks. It is also offered as desktop version.

Versions of the KISS 1U Short platform:



Fig. 2: Rackmount version with closed access door



Fig. 3: Desktop version with closed access door



Fig. 2a: Rackmount version with opened access door



Fig. 3a: Desktop version with opened access door

The system can be equipped with up to two front accessible drive bays (1x 5.25" Slim-line 1x 3.5") and one internal drive bay (1x 2.5").

The operating controls and LED-indicators of the KISS 1U Short platform are located behind the front access door and include the power button, the reset-button, the power-LED and the hard disk activity-LED.

The fans (2x2 fans) are built into the system by means of a fan slide-in module.

The washable filter mats, which protect your system against dust and dirt, are located behind the air grilles of the front access door. The filter mats are changeable while the KISS 1U Short platform is powered-up.

The type label is attached to the right side of the unit.



Fig. 4: KISS 1U Short platform



The horizontal position is the proper operating position for the KISS 1U Short system.

When switching on the system, make sure that the air intake and exhaust openings are not obstructed by objects.

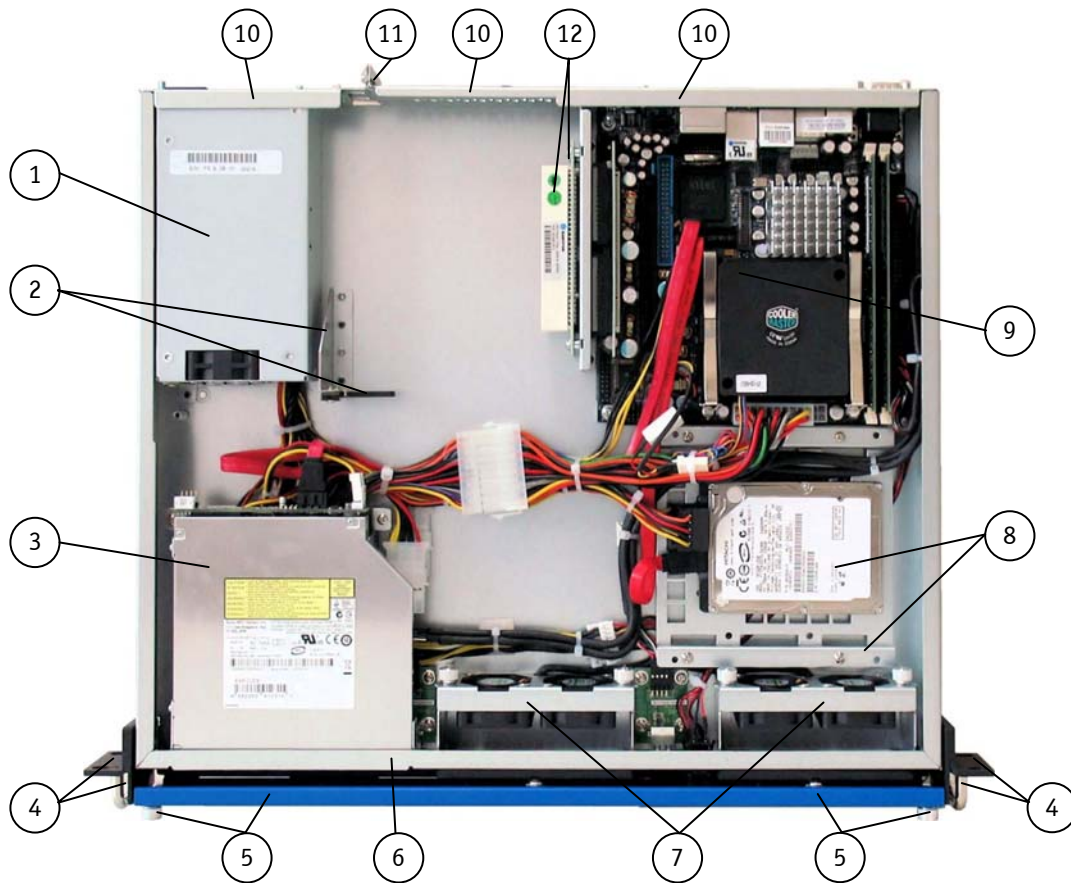

Fig. 5: KISS 1U Short platform, rackmount version, opened

- | | |
|---|--|
| 1 Power Supply Unit (AC) | 6 Fixing brackets for the cover on the front side |
| 2 Card holder (position adjustable) | 7 2x Fan slide-in module (each equipped with two fans) |
| 3 D1 - and D2 -drive (front accessible); D1 and D2 are located one upon the other in one drive cage | 8 Drive holder for the internal 2.5" HDD (D3) |
| 4 19" bracket with handle | 9 Motherboard |
| 5 Front access door with fastening screws | 10 Fixing brackets for the cover on the rear side |
| | 11 2x PCI-slots for expansion cards (half size) |

7.1. Front Side

The system is available as rackmount version.

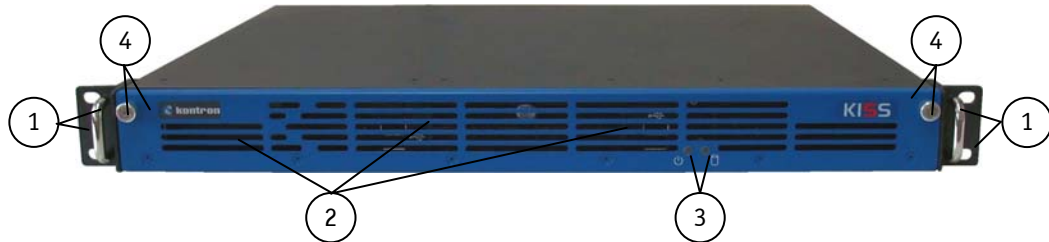
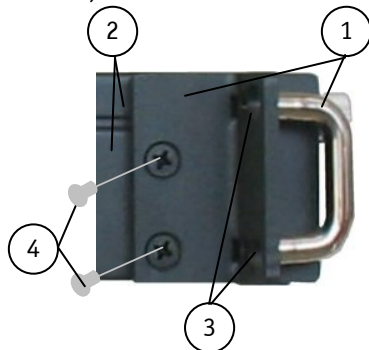

Fig. 6: Front side (rackmount version) with closed front access door

- | | |
|--|--|
| 1 19" rack mountable bracket with handle | 3 Light diffusers for HDD and Power LED indicators |
| 2 Air grilles | 4 Front access door with fastening screws |

You can adapt your system to a desktop unit by removing the two 19" rack mountable brackets with handle (one off on each side).



- | |
|---|
| 1 19" rack mountable bracket with handle |
| 2 Chassis and cover of the KISS 1U Short |
| 3 Holes for mounting in rack cabinets |
| 4 Screws for fastening the 19" rack mountable bracket |

Fig. 7: 19" rack mountable bracket with fastening screws

The power button, the power- and HDD-LED, 4x USB-interfaces, 2x Filter mat holder and the equipped drives are located on the front panel of the KISS 1U Short platform behind the front access door.

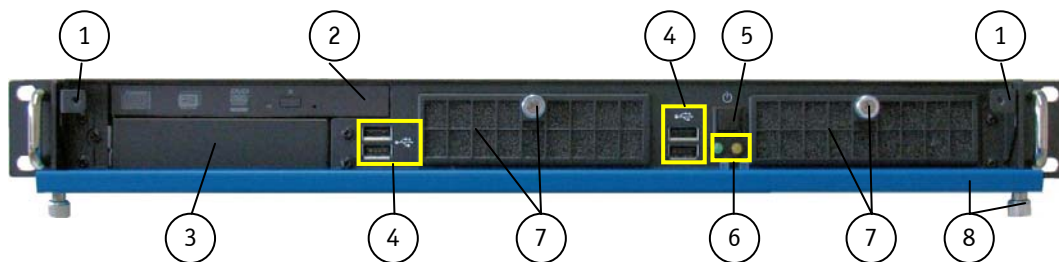

Fig. 8: Front side (rackmount version) with opened front access door

- | | |
|--|--|
| 1 Buffer for the front access door | 5 Power button |
| 2 D1: 5.25" external accessible Slim-line drive bay (shown with one DVD-drive installed) | 6 LED indicators (Power-LED and HDD-LED) |
| 3 D2: 3.5" external accessible drive bay (shown without drive installed) | 7 2x Filter mat holder with captive knurled screws |
| 4 2x2 USB 2.0 | 8 Front access door with fastening screws |

7.1.1. Interfaces on the Front Side

7.1.1.1. USB Interfaces

KISS 1U Short is equipped with four USB interfaces at the front side. These connectors allow you to connect different USB devices to the KISS 1U Short platform.



When USB devices are connected to the USB ports on the front of the device, the front access panel cannot be closed and locked.

7.1.2. Controls and LED Indicators

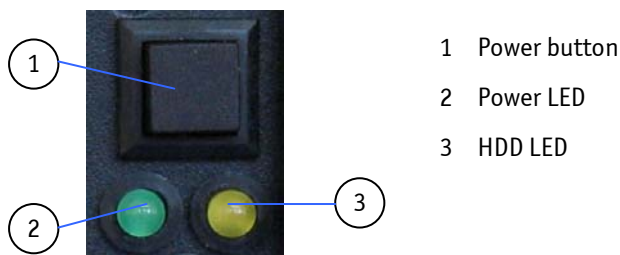

Fig. 9: Power button and LED indicators

Power Button	Press this button to turn the system on or off. Please observe the setting options for the power button in the BIOS-Setup.
Power LED (green)	Lights up green if the system switched on by pressing the "Power button". Prerequisite: The system must be attached by means of the power cord to an appropriate mains (AC).
HDD Activity LED (orange)	Indicates hard disk activity.



Do not press the eject button, while the drive LED is lit or flashing.

7.1.3. Filter Mat Holder

The filter mat holders (Fig. 8, pos. 7) are located behind the air grilles of the front access door inserted into the air filter holder. The filter mat protects your system against dust and dirt. It can be changed while the system is powered up (refer to the section 10.3 "Cleaning the Filter Mat").

7.1.4. External Accessible Drive Bays

Depending on the configuration ordered, your KISS 1U Short can be equipped with up to two externally accessible drives: **D1** (1x 5.25" Slim-line drive bay) and **D2** (1x 3.5" drive bay) (refer to Fig. 8, pos. 2 and pos. 3).

7.2. Rear Side

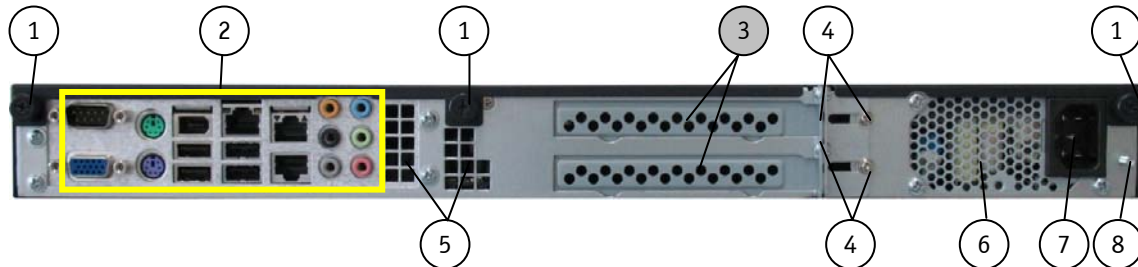

Fig. 10: Rear side of the KISS 1U Short with KTGM45/mITX motherboard

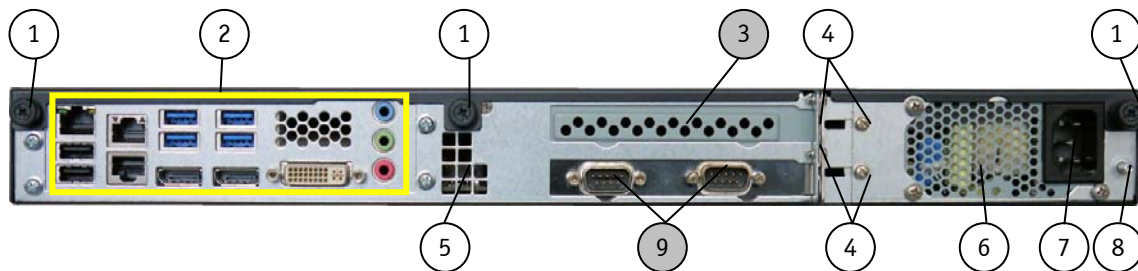

Fig. 11: Rear side of the KISS 1U Short with KTQM77/mITX motherboard

Legend for Fig. 10 and Fig. 11:

- | | | | |
|---|---|---|---|
| 1 | Fastening screws to secure the cover | 5 | Air exhaust openings |
| 2 | Interfaces of the installed motherboard | 6 | Fans of the PSU (AC) |
| 3 | 2x PCI/PCIe free expansion card slots (for configuration with KTGM45) or 1x PCIe x 16 (for configuration with KTQM77) | 7 | AC-power plug |
| 4 | Slide bracket with fixing screws | 8 | Grounding stud |
| | | 9 | 2x serial interfaces (RS232); only available in configuration with KTQM77 |

7.2.1. Interfaces of the Motherboard on the Rear Side



Information and technical data can be found in the corresponding motherboard manual. You can download the relevant motherboard manual for your system configuration from our web site at www.kontron.com by selecting the product name.

7.2.2. Power Supply Unit

The power supply unit (PSU) is placed on the rear side of the KISS 1U Short platform (Fig. 10 and Fig. 11, pos. 6). For information about the integrated power supply unit (PSU) and the rated voltage of your system, refer to the type label attached on the right side of the unit.

7.3. Side View

The four M4 metric tapped holes (Fig. 12, pos. 3) are available at the left and right side of the unit. These can be used in order to attach slide rails (not included in the scope of delivery) to the KISS 1U Short platform for system installation into a 19" industrial cabinet. Refer to the chapter 11 "Slide Rails (Option)".

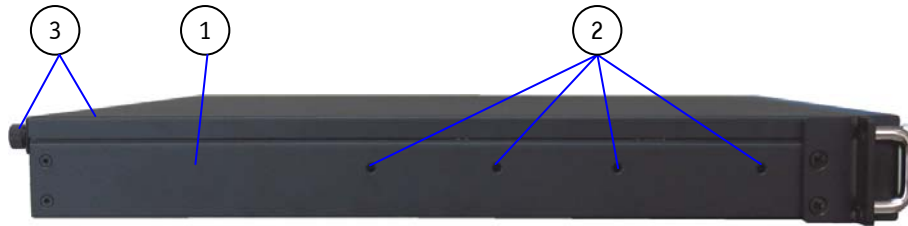

Fig. 12: Side view with tapped M4 metric holes to attach a telescope rail

- | | |
|---|---|
| 1 Side view of the KISS 1U Short platform | 3 Cover with captive knurled screws (to secure the cover to the unit) |
| 2 4x tapped M4 metric holes (on both sides) | |

7.4. Cover

The cover will be fixed to the chassis using three fixing brackets (Fig. 13, pos. 3) and three captive knurled screws (Fig. 13, pos. 1). The fixing brackets are located on the inside of the cover at the front edge. When closing the cover, make sure that the fixing brackets (Fig. 13, pos. 3) will be inserted properly into the corresponding retaining brackets for the cover (Fig. 5, pos. 10) on the rear side of the chassis.

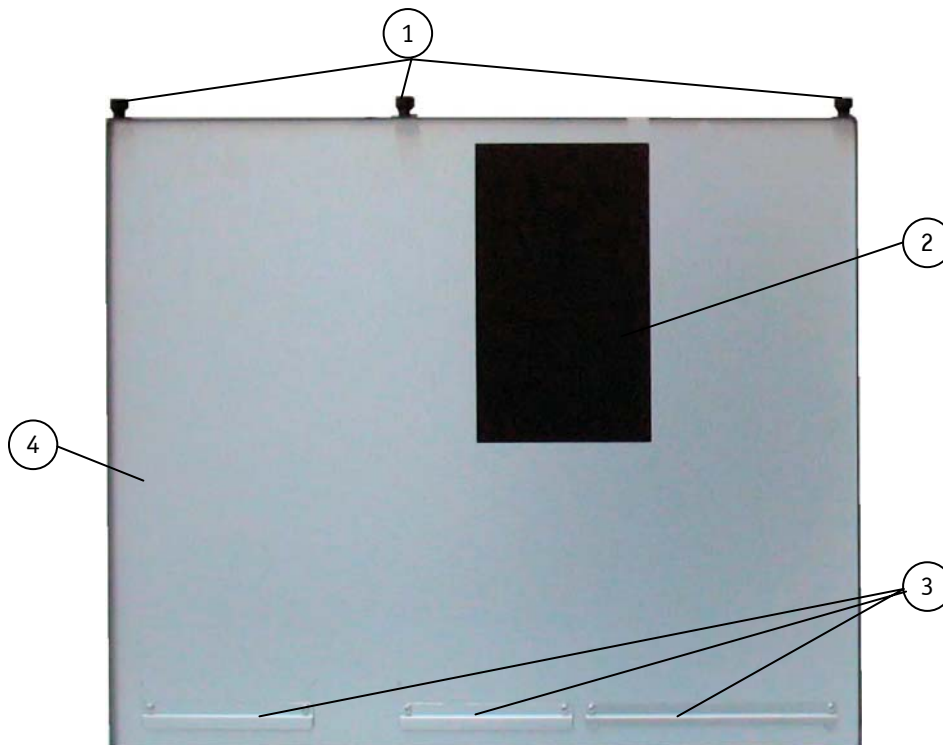

Fig. 13: Inside of the cover with fixing brackets

- | | |
|------------------------------|----------------------------|
| 1 Captive knurled screws | 3 3x front fixing brackets |
| 2 Insulation foil (Makrolon) | 4 Inside of the cover |

7.4.1. Fan Modules

The four front fans are firmly mounted in two fan modules. Thus, a reliable air circulation for an optimal, active cooling of the system is provided. Each fan slide-in module is installed in a fan compartment on the front side of the system.

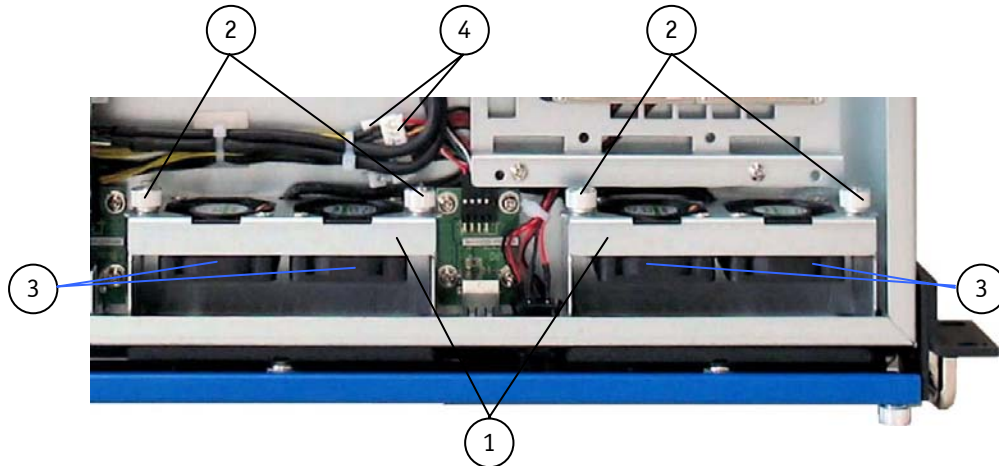

Fig. 14: Fan modules

- 1 Fan modules
- 2 Captive knurled screws of the fan module
- 3 Two fans per fan module
- 4 Fan connection



The KISS 1U Short platform should only be operated with a functioning fan module
Defective components should only be replaced by Kontron.

8. Assembly, Disassembly

8.1. Attaching the Rubber Feet

The rubber feet can be used for the desktop version of the system. Please follow these steps to attach the rubber feet to the bottom side of the chassis:

1. Turn your system off and disconnect it from the mains supply.
2. Make sure that all cards are secured into unit and that the system cover is installed and secured.
3. Turn the system upside down.
4. Remove the protect foil from the delivered self adhesive rubber feet.
5. Attach the self adhesive rubber feet to the bottom side of the chassis.

8.2. Accessing Internal Components

This section contains important information that you should read before accessing the internal components. You should follow these procedures when handling any expansion cardboards.

8.2.1. Installing/Removing the Expansion Cards



When you install (or remove) expansion cards please consider the corresponding safety instruction of the included "General Safety Instruction for IT Equipment".

Activities such as working inside the system or handling the expansion cards have to be carried-out by the service person for this area or a suitably instructed user.



Please observe the safety instruction for handling assemblies with static sensitive device. Failure to take heed of this warning instruction can result in damage to the device.



Please consult the documentation provided by the manufacturer of the expansion card for instructions before attempting to install/remove an expansion card into/from the KISS 1U Short platform.

To install or remove an expansion card, perform the following steps:

1. Turn off your system and disconnect the power cord from the mains.
2. Loosen the fastening screws on the rear side of the unit that secure the cover.



Fig. 15: Loosening the three fastening screws on the rear side of the KISS 1U Short system

3. Pull the cover back (to remove the cover fixing brackets (see Fig. 13, pos.3) from the retaining brackets Fig. 5, pos. 6).



Fig. 16: Sliding the cover back will pull out the cover fixing brackets from the retaining brackets of the chassis

4. Lift the cover (on the rear edge) and remove it (Fig. 17).



Fig. 17: Removing the cover

5. In order to remove the slot or card brackets remove the screws (Fig. 18, pos. 2). Retain these screws for later use. Loosen (turn 1/2 to the left) the fastening screws (Fig. 18, pos. 4) to unlock the slide bracket (Fig. 18, pos. 3).

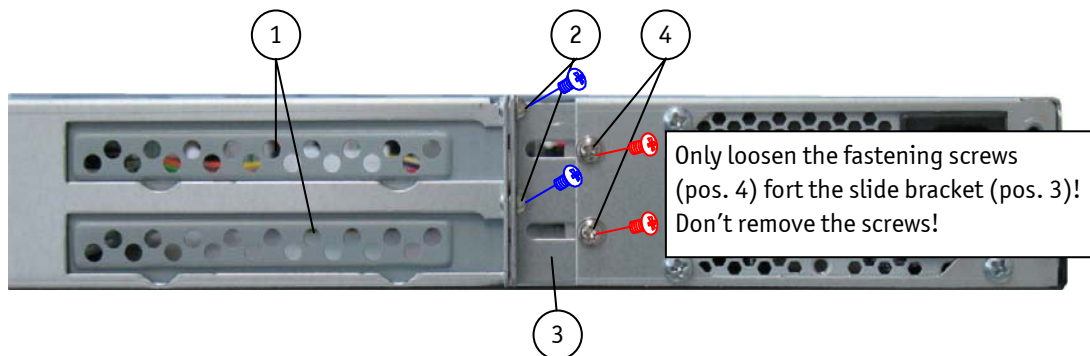

Fig. 18: Detail: Rear side with slide bracket closed (for fixing the expansion cards/slot brackets)

- | | |
|---|---|
| 1 Slot bracket | 3 Slide bracket |
| 2 Fastening screws for the slot bracket (card slot bracket) | 4 Fastening screw for the slide bracket |

6. Move the slide bracket to the left. The slot brackets are disengaged now and can be removed from the system.

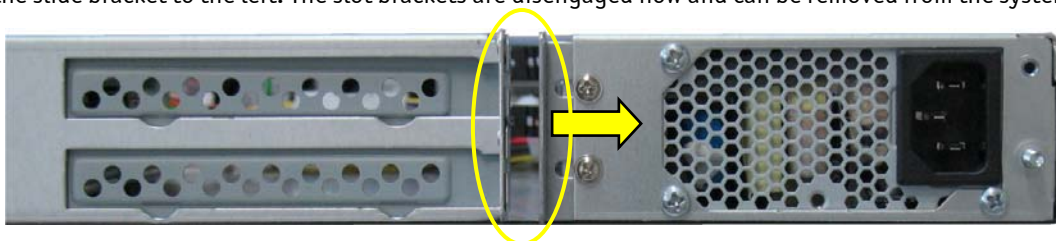

Fig. 19: Detail: Rear side with slide bracket (opened)

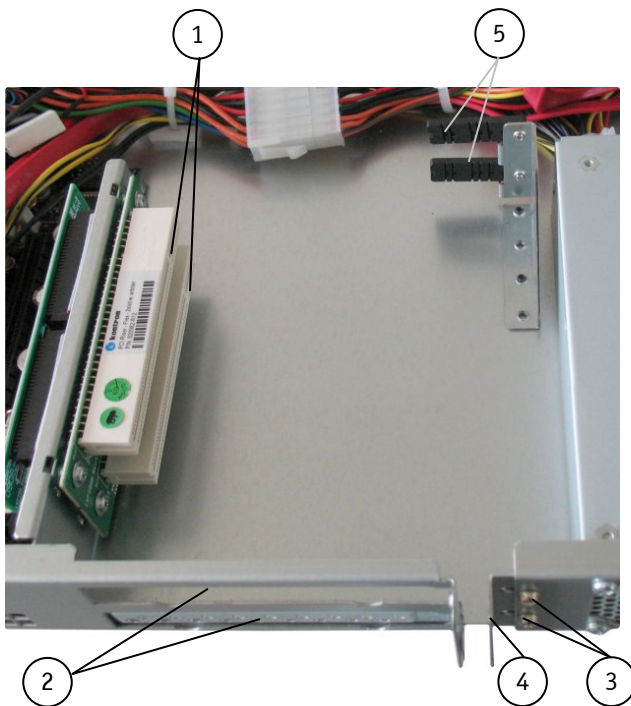

Fig. 20: Detail with opened slide brackets for 2x PCI-card slots (Config. with KTGM45)

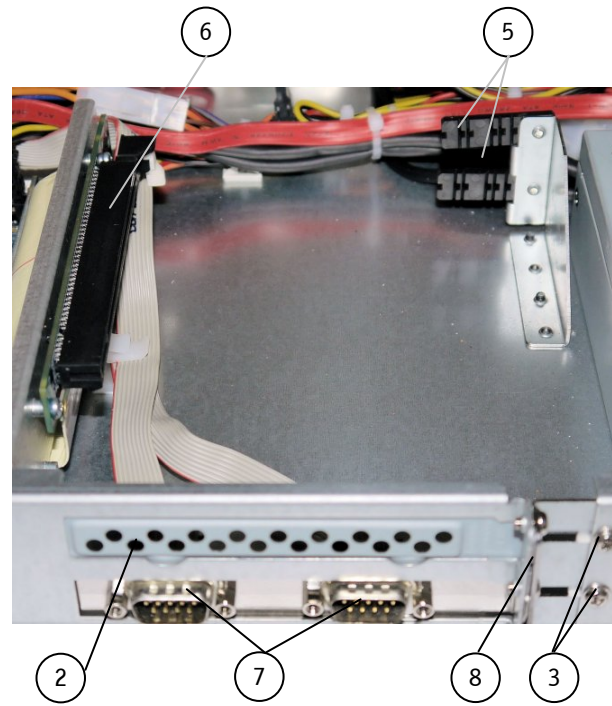

Fig. 21: Detail closed slide brackets, 1x PCIe x16-card slot (Config. with KTQM77)

Legend for Fig. 20 and Fig. 22:

- | | |
|--|---|
| 1 Free expansion slots for 2x PCI cards or with another adapter 1x PCIe x16 expansion card (Config. with KTGM45) | 5 Card holder |
| 2 Slots for expansion cards | 6 Free expansion slots for 1x PCIe x16 card (Config. with KTQM77) |
| 3 Fastening screws of the slide brackets | 7 2x COM (RS232) (available only in config. with KTQM77) |
| 4 slide bracket (opened) | 8 Slide bracket closed |

7. Insert/remove the expansion card into/out of the PCI/PCIe slot.
8. Position the bracket of the expansion card or the slot bracket at the rear side of the chassis.
9. Move the slide bracket (Fig. 20, pos. 4) to the right until it rests firmly on the brackets of the expansion cards and the slot bracket, respectively.
10. Lock the slide bracket in this position by fastening retained the screws (Fig. 18, pos. 2) firmly.
11. Secure the slide bracket position with the fastening screws (Fig. 20, pos. 3)
12. Close the device and secure the cover with the fastening screws (Fig. 10, Fig. 13, pos. 1) on the rear side.



When closing the cover, make sure that the cover fixing brackets (Fig. 13, pos. 3) slide into the corresponding retaining brackets (Fig. 5, pos. 6) of the chassis.

8.3. Instruction for Installation in a 19" Cabinet



In order to setting-up installing / removing the KISS 1U Short platform into/from a 19" industrial cabinet, please observe the instructions described in this manual.

The system has to be mounted and installed only by the service person for this area familiar with the associated dangers.

Ensure there is sufficient air circulation around the device when installing the KISS 1U Short platform.

The openings for air intake and exhaust on the device must not be obstructed by objects.

Leave at least 5 cm (1.969 ") of free space in front and behind the unit to prevent the device from possibly overheating!

The KISS 1U Short platform should be installed into a 19" industrial cabinet with slide rails. The 19" industrial cabinet must stand firmly in place. You can improve its stability by placing the components into it from the bottom up. Heavy components should be placed down below.

If further stabilization is necessary, then bolt the 19" industrial cabinet to the floor or anchor it on the wall.

The voltage feeds must not be overloaded. Adjust the cabling and the external overcharge protection to correspond with the electrical data indicated on the type label.

The type label is located on right side of the unit.

9. Starting Up



The rated voltage of the mains (AC) must agree with the voltage value on the type label.

9.1. AC-Power Cord Connection

The AC power plug of the PSU is located on the rear side of the KISS 1U Short platform.



Use the power cord suitable for the mains in your country.

Do not remove or alter the grounding prong on the power cord. In situations where a two-slot receptacle is present, have it replaced with a properly grounded three-prong grounding type receptacle.



Fig. 22: KISS 1U Short (shown as system with AC-power connection)

1. Fig. 22).
2. Connect the other end of the AC power cord into a corresponding mains outlet for Class I equipment.

9.2. Operating System and Hardware Components Drivers

The KISS 1U Short system can optionally be supplied with or without a pre- installed operating system.

If you have ordered your system with a pre- installed operating system, all drivers are installed, corresponding to the ordered computer configuration (optional hardware components). Your computer is fully operational, when you switch it on for the first time. Please observe the information below.



Important information for using the pre-installed “WINDOWS 7 ULTIMATE FOR EMBEDDED SYSTEMS” or “WINDOWS 7 PROFESSIONAL FOR EMBEDDED SYSTEMS” operating systems:

The terms and condition for using the pre-installed operating systems are defined in the document „MICROSOFT SOFTWARE LICENSE TERMS“.

This document can be downloaded from our web site www.kontron.com by selecting the product name/tab Downloads/Windows.

If you have ordered your system without a pre- installed operating system, you have to install the operating system and the corresponding drivers for the ordered computer configuration (optional hardware components).



The needed drivers for the hardware configuration of your system can be downloaded from the web page www.kontron.com by selecting the product name.

Consider the manufacturer's specifications for the operating system and the integrated hardware components.

10. Maintenance and Prevention

Kontron Embedded Computers systems require minimal maintenance and care to keep them operating correctly.

- Occasionally wipe the system with a soft dry cloth.
- You should only remove persistent dirt by use of a soft, slightly damp cloth (use only a mild detergent).
- Clean the air filter mats regularly (refer to the "Cleaning the Filter Mat" section).

10.1. Replacing the Lithium Battery

The integrated motherboard of your system is equipped with a lithium battery. To replace the battery, please proceed as follows:

1. Open the unit as described in the chapter 8.2.1 "Installing/Removing the Expansion Cards" (step 1-4).
2. Remove the old battery by pressing outwards on the ejector spring.
3. Place the new battery into the socket.
4. Make sure that you insert the battery the right way around. The plus pole must be on the top!
5. The lithium battery must be replaced with an identical battery or a battery type recommended by Kontron Embedded Computers. The Lithium battery type must be UL listed.
6. Close the unit as described in chapter 8.2.1 "Installing/Removing the Expansion Cards" (step 12).



Caution

Danger of explosion when replacing with wrong type of battery. Replace only with the same or equivalent type recommended by the manufacturer. The lithium battery type must be UL recognized.



Do not dispose of lithium batteries in general trash collection. Dispose of the battery according to the local regulations dealing with the disposal of these special materials, (e.g. to the collecting points for dispose of batteries).

10.2. Replacing the System's Fans



The operation of the KISS 1U Short is permitted only with functional fan modules.

Defective components should only be replaced only by Kontron.

10.3. Cleaning the Filter Mat

The filter mat is inserted in the filter mat holder at the front side of the system. Cleaning frequency of the filter mat will depend on the operating environment.

If the environment is extremely dusty, clean the filter mat more often. The filter mat may be changed while the system is powered-up.

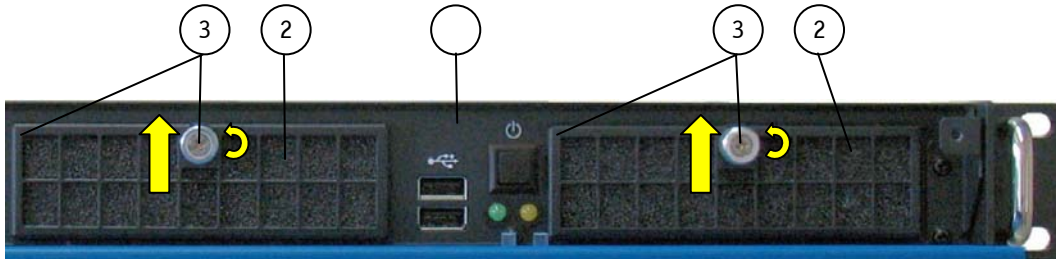

Fig. 23: Detail of the front side - Location of the filter mat

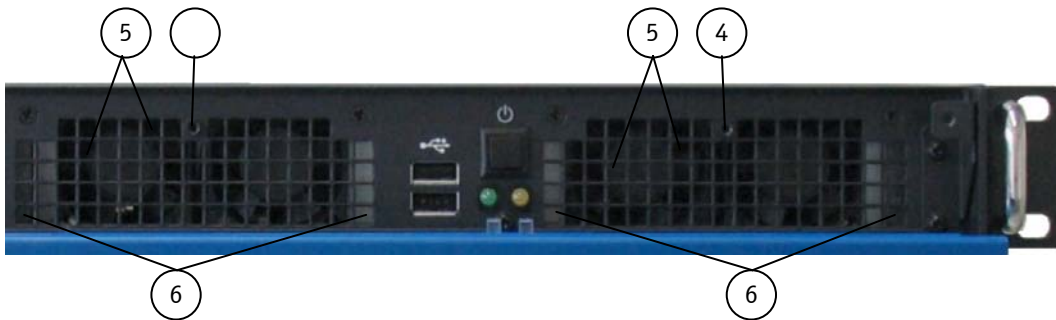

Fig. 24: Detail: front side without filter mat and filter mat holder



Fig. 25: Filter mat

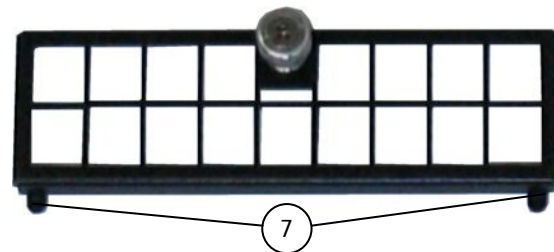

Fig. 26: Filter mat holder

Legend for Fig. 23, Fig. 24 and Fig. 26:

- | | |
|---|---|
| 1 Front side of the KISS 1U Short | 4 Tapped hole for knurled screw |
| 2 Filter mat | 5 Air intake openings |
| 3 Filter mat holder with knurled screws | 6 Positioning holes for the filter mat holder |
| | 7 Positioning lugs of the filter mat holder |

To replace or clean the air filter mat, proceed as follows:

1. Open the front access door (Fig. 6, pos. 4).
2. Loosen the knurled screw (Fig. 23, pos. 3) that secure the filter mat holder with the air filter mat to the chassis.
3. Pull out the filter mat holder (Fig. 23, pos. 3) into the marked direction.

4. Remove the dirty filter mat (Fig. 23, pos. 2 or Fig. 25).
5. To clean the filter mat:
 - Rinse in water (up to approx. 40°C; you may add mild-duty commercial detergent).
 - It is also possible to beat it out, vacuum it or blast it with warm compressed air.
 - If the filter is soiled with greasy dust, you should rinse it with warm water with degreaser added. Do not clean the filter mat with a piercing jet of water or wring it out.
6. After cleaning and drying the filter mat, replace it into the filter mat holder. Insert the positioning lugs of the filter mat holder (Fig. 26, pos. 7) into the positioning holes (Fig. 24, pos. 6) at the front side of the chassis.
7. Tighten the knurled screws to secure the filter mat holders to the chassis.



When inserting the filter mat, ensure that the denser side of the mat is facing the fans.



Defective components may be replaced only by Kontron original spare parts.

Part number of the filter mat: 1017-2544

11. Slide Rails (Option)

Kontron offers slide rails for installing the KISS 1U Short platform into a 19" industrial cabinet. These can be ordered under: "Slide rails" - Set No.: 3-A260-0244.

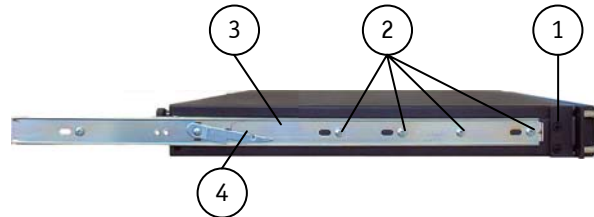

Fig. 27: Attaching the inner side of the slide rail



Fig. 28: KISS 1U Short with slide rails in pulled-out position



Fig. 29: KISS 1U Short with slide rails

Legend for figures: Fig. 27, Fig. 28 and Fig. 29:

- | | |
|--|-------------------------------------|
| 1 Side view of the KISS 1U Short | 4 Locking/unlocking lever |
| 2 4x M4x6 rounded head screw (per each side of the unit) | 5 Slide rail in pulled-out position |
| 3 Slide rail inner part | 6 Slide rail in pushed-in position |



Only the specified M4x6 screws should be used to attach telescope rails to the KISS 1U Short platform.

11.1.1. Slide Rails Accessories and Assembling

The "Slide Rails" set consists of following elements:

- One pair of slide rails
- One pair of short front brackets (with screws and washers)
- One pair of long rear brackets (with screws and washers)
- 2x bar nut kits
- 8x M4x6 flathead screws

For assembling refer to Fig. 30.

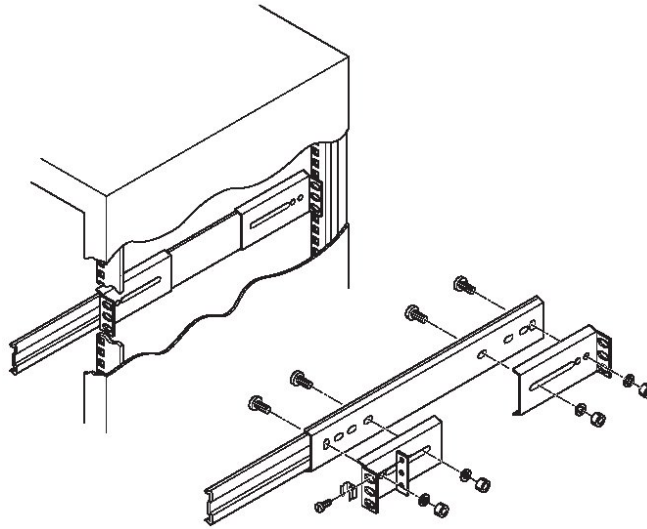

Fig. 30: Assembling the "Telescopic Rail" set



Short brackets are usually used at the front of the chassis and long brackets at the rear.

12. Main Specifications

KISS 1U Short-xxx-y	
Installed Board	* refer to “Configuration Guide”
Interfaces	Interfaces of the board slot * refer to the manual of the installed board
Drive Bays	* Optional configuration (depending on the system configuration ordered (refer also to “Configuration Guide”)
Free Expansion Card Slots	2x PCI or 1x PCIe x16 (depending on the installed motherboard)
Power Consumption per Expansion Slot (PCI)	max. 25 W
Lithium Batterie	CR2032; 3.0 V; 0.22Ah
Rated Voltage Range	230V AC



KISS 1U Short = System type

The “xxxxxxx”-Group is replaced by figures (100 through 999), representing the built-in CPU board.

“y” is replaced by a single letter (A through Z) representing the power supply installed in the system.*

The corresponding “Configuration Guide” and the manual of the installed board can be downloaded from our web site at www.kontron.com by selecting the product name.

12.1. Electrical Specifications

The electrical specification you can read off on the type label of your KISS 1U Short platform.

12.2. Mechanical Specifications

Dimension	KISS 1U Short
Height	1U; 44 mm (1.73")
Width	Front: 19"; Gehäuse: 430 mm (16.9")
Depth	Chassis: 350 mm (13.779")
Weight	Approx. 6 kg (13.228 lbs.)
Chassis	Chassis: steel sheet, black (RAL 7021) Access door: steel sheet, blue (RAL 5017)

12.3. Environmental Specifications

Operating temperature / relative humidity	0 ... +45 °C / 20-90 % not condensing (32 ... 113 °F / 20-90 %) not condensing	
Storage / transit temp. / relative humidity	-20 ... +70 °C / 10-90 % not condensing (-4 ... 158 °F / 10-90 %) not condensing	
Operating altitude	2,000 m (6,562 ft)	
Storage / transit altitude	10,000 m (32,810 ft)	
Pollution Degree	2	
Protection Class	Front IP20	
	KISS 1U Short KTGM45	KISS 1U short KTQM77
Operating Shock	5 G, 11 ms duration, half sine	
Operating Shock Vertical Operating Shock Horizontal		15 G, 30 ms duration, half sine 10 G, 45 ms duration, half sine
Storage/Transit Shock	15 G., 11 ms duration, half sine	30 G, 11 ms, duration, half sine
Operating Vibration	10 – 500 Hz, 0.5 G	5 – 500 Hz, 1.0 G
Storage / Transit Vibration	10 – 500 Hz, 2.0 G	5 – 500 Hz, 2.0 G

12.4. CE Directives and Standards

CE Directives	
Electrical Safety	General Product Safety Directive (GPSD) 2001/95/EC Low Voltage Directive (LVD) 2006/95/EC
ElectroMagnetic Compatibility (EMC)	EMC Directive 2004/108/EC
RoHS II Directives	2011/65/EU

Electrical Safety	Harmonized Standards
EUROPE	Information technology equipment - Safety - Part 1: General requirements EN 60950-1: 2006
U.S.A. / KANADA	to meet UL60950-1:2007 / CSA C22.2- No. 60950-1-7:2007
CB Scheme	CB Certification (for KISS 1U Short KTQM77 only)

EMC	Harmonized Standards
EU	Generic emission standard for industrial environments (Emission): EN 61000-6-4:2007 Generic standards - Immunity for industrial environments (Immunity): EN 61000-6-2:2005
U.S.A.	FCC 47 CFR Part 15, Class A
KANADA	ICES-003, Class A

13. Standard Interfaces – Pin Assignments

Low-active signals are indicated by a minus sign.

13.1.1. Serial Interface COM (RS232)

Pin	Signal Name	9-pin D-SUB Connector
1	DCD (Data Carrier Detect)	
2	RXD (Receive Data)	
3	TXD (Transmit Data)	
4	DTR (Data Terminal Ready)	
5	GND (Signal Ground)	
6	DSR (Data Set Ready)	
7	RTS (Request to Send)	
8	CTS (Clear to Send)	
9	RI (Ring Indicator)	

13.1.2. VGA Port

Pin	Signal Name	15-pin D-SUB Connector (female)
1	Analog red output	
2	Analog green output	
3	Analog blue output	
4	N.C.	
5-8	GND	
9	+5 V (DDC)	
10	GND	
11	N.C.	
12	SDA (DDC)	
13	TTL HSync	
14	TTL VSync	
15	SCL (DDC)	

13.1.3. PS/2 Mouse Connector

Pin	Signal Name	6-pin Mini-DIN Connector
1	Mouse data	
2	N.C.	
3	GND	
4	++5V/SB5V	
5	Mouse clock	
6	N.C.	

13.1.4. PS/2 Keyboard Connector

Pin	Signal Name	6-pin Mini-DIN Connector
1	Keyboard data	
2	N.C.	
3	GND	
4	++5V/SB5V	
5	Keyboard clock	
6	V.C.	

13.1.5. USB Port

Pin	Signal Name	4-pin USB Connector Type A Version 2.0
1	VCC	
2	Data-	
3	Data+	
4	GND	

13.1.6. USB Port (3.0)

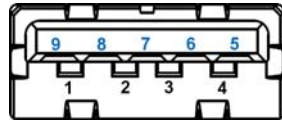
Pin		Signal Name	9-pin USB Socket Type A Version 3.0/2.0
USB 2.0 contact pins	USB 3.0 contact pins		
1	VCC, fused (900 mA max.)	5 StdA_SSRX-	
2	Data-	6 StdA_SSRX+	
3	Data+	7 GND_DRAIN	
4	GND	8 StdA_SSTX-	
		9 StdA_SSTX+	

13.1.7. DVI-I (Single Link) Interface

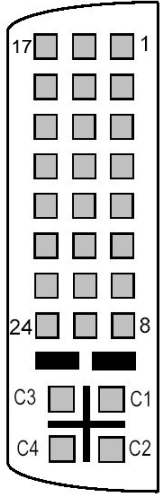
Pin	Signal Name	Description	DVI-I Connector (female)
1	TMDS2-	Differential TMDS Data 2-	
2	TMDS2+	Differential TMDS Data 2+	
3	GND	TMDS 2/4 Shield	
4-5	NC		
6	DVI_SCL	DDC EDID data clock	
7	DVI_SDA	DDC EDID data	
8	DVI_VS	Analog VSYNC	
9	TMDS1-	Differential TMDS Data 1-	
10	TMDS1+	Differential TMDS Data 1+	
11	GND	TMDS Shield	
12-13	NC		
14	DVI_5V	5V / 100mA Power Supply	
15	GND	Ground	
16	DISPDET	Hot Plug Detection	
17	TMDS0-	Differential TMDS Data 0-	
18	TMDS0+	Differential TMDS Data 0+	
19	GND	TMDS Shield	
20-21	NC		
22	GND	TMDS Shield	
23	TMDS_SCL+	Differential TMDS Clock+	
24	TMDS_SCL-	Differential TMDS Clock -	
C1	DVI_R	Analog red	
C2	DVI_G	Analog green	
C3	DVI_B	Analog blue	
C4	DVI_HS	Analog HSYNC	
C5-C6	GND	Ground	

Note: The +5V supply is fused.

14. Technical Support

For technical support, please contact our Technical Support department:

Tel: +49 (0) 8165/77 112
 e-mail: support-keu@kontron.com
 Web: <http://www.kontron.com/support>

Make sure you have the following information on hand when you call:

- the unit part id number (PN),
- the serial number (SN) of the unit; the serial number can be found on the type label, placed on the right side of the system.

Be ready to explain the nature of your problem to the service technician.

If you have questions about Kontron Europe or our products and services, you can reach us by the above-mentioned telephone number and on e-mail address or at: www.kontron.com.

14.1. Returning Defective Merchandise

Please follow these steps before you return any merchandise to Kontron Europe:

1. Download the corresponding form for returning a device with an RMA No. [RMA (Return of Material Authorization)] from our website www.kontron.com / Support / .RMA Information; contact our Customer Service department to obtain an RMA No.
 e-Mail: service@kontron.com
2. Ensure that you have received an RMA number from Kontron Customer Services before returning any device. Write this number clearly on the outside of the package.
3. Describe the fault that has occurred.
4. Please provide the name and telephone number of a person we can contact to obtain more information, where necessary. Where possible, please enclose all the necessary customs documents and invoices.
5. When returning a device:
 - Pack it securely in its original box.
 - Enclose a copy of the RMA form with the consignment.

Corporate Offices

Europe, Middle East & Africa	North America	Asia Pacific
Oskar-von-Miller-Str. 1 85386 Eching/Munich Germany Tel.: +49 (0)8165/ 77 777 Fax: +49 (0)8165/ 77 219 info@kontron.com	14118 Stowe Drive Poway, CA 92064-7147 USA Tel.: +1 888 294 4558 Fax: +1 858 677 0898 info@us.kontron.com	17 Building,Block #1,ABP. 188 Southern West 4th Ring Beijing 100070, P.R.China Tel.: + 86 10 63751188 Fax: + 86 10 83682438 info@kontron.cn