

# » Kontron User's Guide «



## KISS 4U Short V2

User's Guide (Version 1.01)

0-0096-6849

This page is intentionally left blank.

# 1. Table of Contents

<b>1. Table of Contents</b> .....	<b>1</b>
1.1. Table of Figures .....	2
<b>2. Introduction</b> .....	<b>4</b>
2.1. Symbols used in this Manual .....	5
<b>3. Important Instructions</b> .....	<b>6</b>
3.1. Warranty Note .....	6
3.2. Exclusion of Accident Liability Obligation .....	6
3.3. Liability Limitation / Exemption from the Warranty Obligation .....	6
<b>4. General Safety Instructions for IT Equipment</b> .....	<b>7</b>
4.1. Operation of Laser Source Devices .....	7
4.2. Electrostatic Discharge (ESD) .....	8
4.2.1. Grounding Methods .....	8
4.3. Instructions for the Lithium Battery .....	8
<b>5. Electromagnetic Compatibility (Class A Device)</b> .....	<b>9</b>
5.1. Electromagnetic Compatibility (EU) .....	9
5.2. FCC Statement (USA) .....	9
5.3. EMC Compliance (Canada) .....	9
<b>6. Scope of Delivery</b> .....	<b>10</b>
6.1. Type Label and Product Identification .....	10
<b>7. Product Description</b> .....	<b>11</b>
7.1. Front Side .....	14
7.1.1. Interfaces on the Front Side .....	16
7.1.2. Controls and LED Indicators .....	16
7.1.3. Front Access Panel .....	17
7.1.4. Cover fastening screw on the front side .....	17
7.1.5. Filter Mat and Filter Mat Holder .....	17
7.1.6. Fan Slide-in module .....	18
7.1.7. Drive Bays .....	18
7.2. Rear Side .....	19
7.2.1. Interfaces on the Rear Side .....	20
7.2.2. Power Supply Unit and PSU Switch .....	22
7.2.3. Grounding Stud .....	23
7.3. Side View .....	24
<b>8. Assembly, Disassembly</b> .....	<b>25</b>
8.1. Attaching the Rubber Feet .....	25
8.2. Device Cover .....	25
8.3. Fan Slide-in Module and Temperature Sensor .....	26
8.4. Accessing Internal Components .....	27
8.4.1. Installing/Removing the Expansion Cards .....	27
8.5. Installation in a 19" Industrial Cabinet .....	30
<b>9. Starting Up</b> .....	<b>31</b>
9.1. AC Power Connection .....	31

9.2. DC Power Connection .....	32
9.2.1. Attaching the Ferrite Core .....	32
9.2.2. DC Power Cord Connection .....	33
9.3. Operating System and Hardware Component Drivers .....	34
<b>10. Maintenance and Prevention.....</b>	<b>35</b>
10.1. Cleaning the Filter Mat .....	35
10.1.1. Cleaning Steel Mesh Guard (for IP52 Protection Class only).....	37
10.2. Replacing the System Fans .....	38
10.3. Replacing the Lithium Battery .....	40
<b>11. Slide Rails (Option) .....</b>	<b>41</b>
<b>12. Technical Data.....</b>	<b>42</b>
12.1. Electrical Specifications .....	42
12.2. Mechanical Specifications .....	43
12.3. Environmental Specifications .....	43
12.4. CE Directives and Standards .....	44
<b>13. Standard Interfaces – Pin Assignments .....</b>	<b>45</b>
13.1. Serial Interface (RS232) .....	45
13.2. VGA Port.....	45
13.3. USB Port.....	46
13.4. PS/2 Keyboard Connector .....	46
13.5. PS/2 Mouse Connector .....	46
<b>14. Technical Support.....</b>	<b>47</b>
14.1. Returning Defective Merchandise .....	47

## 1.1. Table of Figures

Fig. 1: Laser radiation warning label .....	7
Fig. 2: Rackmount version with closed access panel .....	11
Fig. 3: Desktop version with closed access panel .....	11
Fig. 4: Rackmount version with opened access panel.....	11
Fig. 5: Desktop version with opened access panel.....	11
Fig. 6: KISS 4U Short V2, opened rackmount version (shown with a KTQ 45/Flex motherboard) .....	13
Fig. 7: Front side (rackmount version) with closed front access panel.....	14
Fig. 8: 19" Handle bracket with fastening screws.....	14
Fig. 9: Front side (rackmount version) with opened access panel.....	15
Fig. 10: Power button and USB ports at the front side .....	16
Fig. 11: Indicators on the front side.....	17
Fig. 12: Rear side of a KISS 4U Short V2 platform (shown with KTQ45/Flex motherboard).....	19
Fig. 13: Rear side of a KISS 4U Short V2 platform (shown with KTQ67/Flex motherboard).....	19
Fig. 14: External ports of the KTQ45/Flex motherboard .....	20
Fig. 15: External ports of the KTQ67/Flex motherboard .....	21

Fig. 16: Detail: AC Wide Rang PSU .....	22
Fig. 17: Detail: +24VDC PSU .....	22
Fig. 18: Detail: -48VDC PSU .....	22
Fig. 19: Grounding stud marked with PE symbol.....	23
Fig. 20: Unmarked grounding stud.....	23
Fig. 21: KISS 4U Short V2 platform – side view.....	24
Fig. 22: Inside of the cover with fixing brackets .....	25
Fig. 23: Fan slide-in module .....	26
Fig. 24: Lösen der Deckel-Anziehschraube an der Frontseite .....	27
Fig. 25: Lösen der Rändelschrauben an der Rückseite .....	27
Fig. 26: Pull out the cover centering and fixing brackets from the retaining bracket of the chassis.....	28
Fig. 27: Removing the cover .....	28
Fig. 28: Card hold down bracket for long expansion cards.....	28
Fig. 29: Opened KISS 4U Short V2 platform - removing the card hold down brackets .....	29
Fig. 30: KISS 4U Short V2, rear side without PE marked grounding stud.....	31
Fig. 31: Opened ferite core with wires .....	32
Fig. 32: Detail: Filter mat holder on the front side of the KISS 4U Short V2 platform .....	35
Fig. 33: Detail: without filter mat at the front side .....	36
Fig. 34: Filter mat holder without filter mat .....	36
Fig. 35: Filter mat holder with filter mat.....	36
Fig. 36: Filter mat .....	36
Fig. 37: IP52 - Filter mat holder with inserted steel mesh guard and filte rmat.....	37
Fig. 38: Steel mesh guard.....	37
Fig. 39: IP52 variant - Positioning of the steel mesh guard and of the filter mat in the filter mat holder.....	37
Fig. 40: Detail: Fan slide-in module without filter mat holder .....	38
Fig. 41: Detail: Fan compartment (without fan slide-in module) .....	38
Fig. 42: Inner sider of the fan slide-in module.....	39
Fig. 43: Fan slide-in module with inserted filter mat.....	39
Fig. 44: Location of the Lithium Battery .....	40

## 2. Introduction

Kontron Europe GmbH would like to point out that the information contained in this manual may be subject to technical alteration, particularly as a result of the constant upgrading of Kontron Europe products. The attached documentation does not entail any guarantee on the part of Kontron Europe with respect to technical processes described in the manual or any product characteristics set out in the manual. Kontron Europe does not accept any liability for any printing errors or other inaccuracies in the manual unless it can be proven that Kontron Europe is aware of such errors or inaccuracies or that Kontron Europe is unaware of these as a result of gross negligence and Kontron Europe has failed to eliminate these errors or inaccuracies for this reason. Kontron Europe expressly informs the user that this manual only contains a general description of technical processes and instructions which may not be applicable in every individual case. In cases of doubt, please contact Kontron Europe.





This manual is protected by copyright. All rights are reserved by Kontron Europe. Copies of all or part of this manual or translations into a different language may only be made with the prior written consent of Kontron Europe. Kontron Europe points out that the information contained in this manual is constantly being updated in line with the technical alterations and improvements made by Kontron Europe to the products and thus this manual only reflects the technical status of the products by Kontron Europe at the time of printing.

© 2012 by Kontron Europe GmbH

Printing and duplication, even of sections, is only permissible with the express approval of

Kontron Europe GmbH  
Office Eching  
Oskar-von-Miller-Str. 1  
85386 Eching  
Germany

## 2.1. Symbols used in this Manual

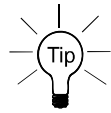
Symbol	Meaning
	This symbol indicates the danger of injury to the user or the risk of damage to the product if the corresponding warning notices are not observed.
	This symbol indicates that the product or parts thereof may be damaged if the corresponding warning notices are not observed.
	This symbol indicates general information about the product and the user manual.
	This symbol indicates detail information about the specific product configuration.
	This symbol precedes helpful hints and tips for daily use.

## 3. Important Instructions

This manual provides important information required for the proper operation of the KISS 4U Short V2 platform!

This chapter contains instructions which must be observed when working with the KISS 4U Short V2 platform.

### 3.1. Warranty Note

Due to their limited service life, parts which by their nature are subject to a particularly high degree of wear (wearing parts) are excluded from the warranty beyond that provided by law. This applies to batteries, for example.

### 3.2. Exclusion of Accident Liability Obligation

Kontron Europe shall be exempted from the statutory accident liability obligation if the user fails to observe the supplied document: "General Safety Instructions for IT Equipment" the hints in this manual or eventually the warning signs label on the device.

### 3.3. Liability Limitation / Exemption from the Warranty Obligation

In the event of damage to the device caused by failure to observe the supplied "General Safety Instructions for IT Equipment", the hints in this manual or eventually the warning signs label on the device, Kontron Europe shall not be required to honor the warranty even during the warranty period and shall be exempted from the statutory accident liability obligation.



## 4. General Safety Instructions for IT Equipment



Please consider the instructions described in the included "General Safety Instructions for IT Equipment".

**Caution:**

**Energy hazards > 240 VA are present inside the chassis!**

**Activities such as system expansion with expansion cards, or maintenance have to be carried-out by qualified personnel familiar with the associated dangers!**

**The installation instruction for the KISS 4U Short V2 platform is the responsibility of the distributor.**

When used as intended the KISS 4U Short V2 platform is to operate only closed and locked.

Only when the cover is properly installed, secured with the knurled screws on the rear and the cover fastening screw on the front, and the access panel is locked with the key, it is ensured that the user doesn't have access to the internal parts of the KISS 4U Short V2 platform, loaded with hazardous energy.

### 4.1. Operation of Laser Source Devices

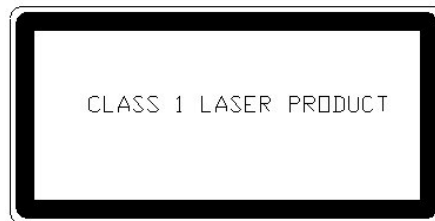

*Fig. 1: Laser radiation warning label*

The optional DVD drive contain light-emitting diodes (classified in accordance with IEC 60825-1:2007: LASER CLASS 1) and therefore must not be opened.

If the enclosure of such a drive is opened, invisible laser radiation is emitted. Do not allow yourself to be exposed to this radiation.

The laser system meets the code of Federal Regulations 21 CFR, 1040 for the USA and the Canadian Radiation Emitting Devices Act, REDR C 1370.



## 4.2. Electrostatic Discharge (ESD)

A sudden discharge of electrostatic electricity can destroy static-sensitive devices or micro-circuitry. Proper packaging and grounding techniques are necessary precautions to prevent damage. Always take the following precautions:

1. Transport boards in static-safe containers such as boxes or bags.
2. Keep electrostatic sensitive parts in their containers until they arrive at the ESD-safe workplace.
3. Always be properly grounded when touching a sensitive board, component, or assembly.
4. Store electrostatic-sensitive boards in protective packaging or on antistatic mats.

### 4.2.1. Grounding Methods

The following measures help to avoid electrostatic damages to the device:

1. Cover workstations with approved antistatic material. Always wear a wrist strap connected to workplace as well as properly grounded tools and equipment.
2. Use anti-static mats, heel straps, or air ionizers to give added protection.
3. Always handle electrostatic sensitive components by their edge or by their casing.
4. Avoid contact with pins, leads, or circuitry.
5. Turn off power and input signals before inserting and removing connectors or connecting test equipment.
6. Keep work area free of non-conductive materials such as ordinary plastic assembly aids and styrofoam.
7. Use field service tools such as cutters, screwdrivers, and vacuum cleaners which are conductive.
8. Always place drives and boards PCB-assembly-side down on the foam.

## 4.3. Instructions for the Lithium Battery

The installed motherboard is equipped with a Lithium battery. When replacing the lithium battery, please follow the corresponding instructions in the chapter 10.3 "Replacing the Lithium Battery".



### Caution

Danger of explosion when replacing with wrong type of battery. Replace only with the same or equivalent type recommended by the manufacturer. The lithium battery type must be UL recognized.



Do not dispose of lithium batteries in general trash collection. Dispose of the battery according to the local regulations dealing with the disposal of these special materials, (e.g. to the collecting points for dispose of batteries).

## 5. Electromagnetic Compatibility (Class A Device)

### 5.1. Electromagnetic Compatibility (EU)

This product is intended only for use in industrial areas. The most recent version of the EMC guidelines (EMC Directive 2004/108/EC) and/or the German EMC laws apply. If the user modifies and/or adds to the equipment (e.g. installation of add-on cards) the prerequisites for the CE conformity declaration (safety requirements) may no longer apply.

**Warning!**

This is a class A product. In domestic environment this product may cause radio interference in which case the user may be required to take adequate measures.

### 5.2. FCC Statement (USA)

This equipment has been tested and found to comply with the limits for a Class A digital device, pursuant to Part 15 of the FCC Rules. These limits are designed to provide reasonable protection against harmful interference when the equipment is operated in commercial environment. This equipment generates, uses, and can radiate radio frequency energy and, if not installed and used in accordance with the instruction manual, may cause harmful interference to radio communications. Operation of this equipment in residential area is likely to cause harmful interference in which case the user will be required to correct the interference at his own expense.

### 5.3. EMC Compliance (Canada)

The method of compliance is self-declaration to Canadian standard ICES-003:

(English): This Class A digital apparatus complies with the Canadian ICES-003.

(French): Cet appareil numérique de la class A est conforme à la norme NMB-003 du Canada.

## 6. Scope of Delivery

- KISS 4U Short V2 platform (ordered system configuration)
- Two keys for the access panel lock
- 1x Ferrite core (for system configuration with DC PSU)
- Rubber feet (self-adhesive)
- AC power cable (for system configuration with AC PSU)
- General Safety Instruction for IT Equipment

### Optional Parts

- Slide Rails (PN: 1016-5807)
- Rack Slide Rails Kit for KISS 1U and KISS 2U/4U V2 (PN: 1051-7200)

### 6.1. Type Label and Product Identification

The type label (product designation, serial number) and the inspection status label of your KISS 4U Short V2 platform are located on the right side of the device.

System Type	Product Designation	Product Identifikation
KISS 4U Short V2	KISS 4U Short V2-xxxxxxx-y	<p>KISS 4U Short V2 = System type</p> <p>The "xxxxxxx" group is replaced by up to a max. 8-digit combination of numbers, letter or space, and represents the installed CPU board</p> <p>The "y" is replaced by a single letter (A through Z) representing the power supply installed into the system.</p>

#### Note for the equipped PSU (Power Supply Unit):

- A:** corresponds to the systems with a wide range AC power supply (100-240V, 400W)
- B:** corresponds to the system configuration with +24 VDC, 300 W power supply
- C:** corresponds to the system configuration with -48 VDC, 300 W power supply

## 7. Product Description

The KISS 4U Short V2 platform expands the Kontron KISS computer line. KISS 4U Short V2 is a scalable 4U (19") platform, that is equipped with a motherboard, supporting various system configurations (refer to "KISS 4U Short V2 System - Configuration Guide" on our website). The flexible customer-specific hardware system configuration and the robust construction with excellent mechanical stability of the KISS 4U Short V2 platform offer the superior qualities of a computer designed for operation in harsh industrial environment.

The KISS 4U Short V2 platform is designed to be operated in horizontal position as desktop unit or installed into a 19" rack.

### Versions of the KISS 4U Short V2 platform:

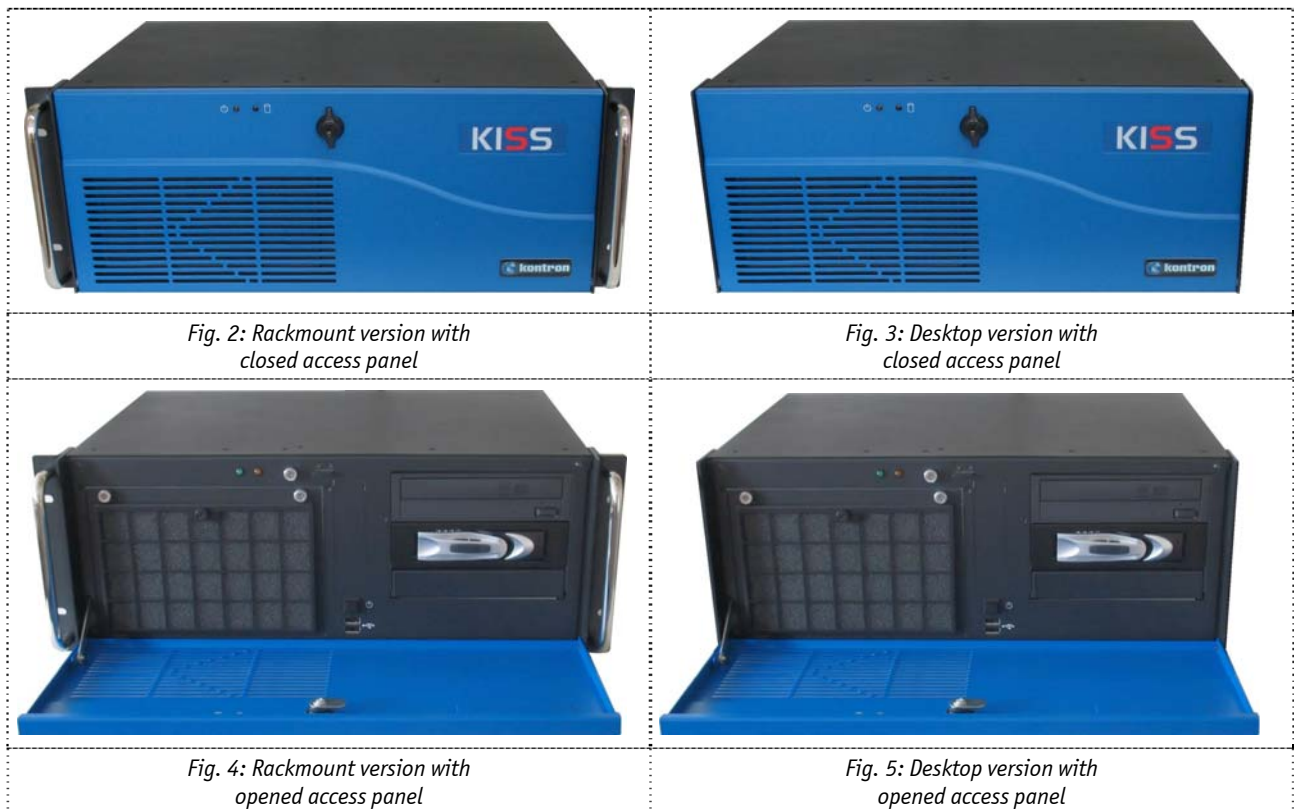

The system can be equipped with up to four drive bays (depending on the system configuration):

- L1 and L2:** two 5.25" front accessible drive bays
- L3:** one internal 3.5" drive bay or one front accessible slim drive.
- L4:** one 3.5" front accessible drive bay



For customized versions and system configurations, please observe the corresponding "KISS 4U Short V2 Systems - Configuration Guides" for KISS 4U Short V2 on our web site [www.kontron.com](http://www.kontron.com).

The power button of the KISS 4U Short V2 platform is located on the front side behind the front access panel. The LED indicators are located on the front side and consist of a “power LED” and a “hard disk activity LED”.

Two system fans are installed at the front side of the unit. These are attached to the system by means of a fan slide-in module. The fan slide-in module simplifies the installation and removal of these components, even during operation.

The washable filter mat, which protects your system against dust and dirt, is located on the front side of the system. This filter mat can be replaced during operation.

On request, the KISS 4U Short V2 platform can optionally be equipped with either an AC wide range, a +24VDC or a -48VDC power supply unit.

The type label is attached to the right side of the device.

The system can be ordered with frontal IP52 Protection Class.



The KISS 4U Short V2 platform may be operated in horizontal position only.

When powering on the KISS 4U Short V2 platform, make sure that the air intake and exhaust openings are not obstructed by objects.

The frontal IP52 protection class for the KISS 4U Short V2 platform is ensured only with an additional inserted steel mesh guard, and with closed front access panel.

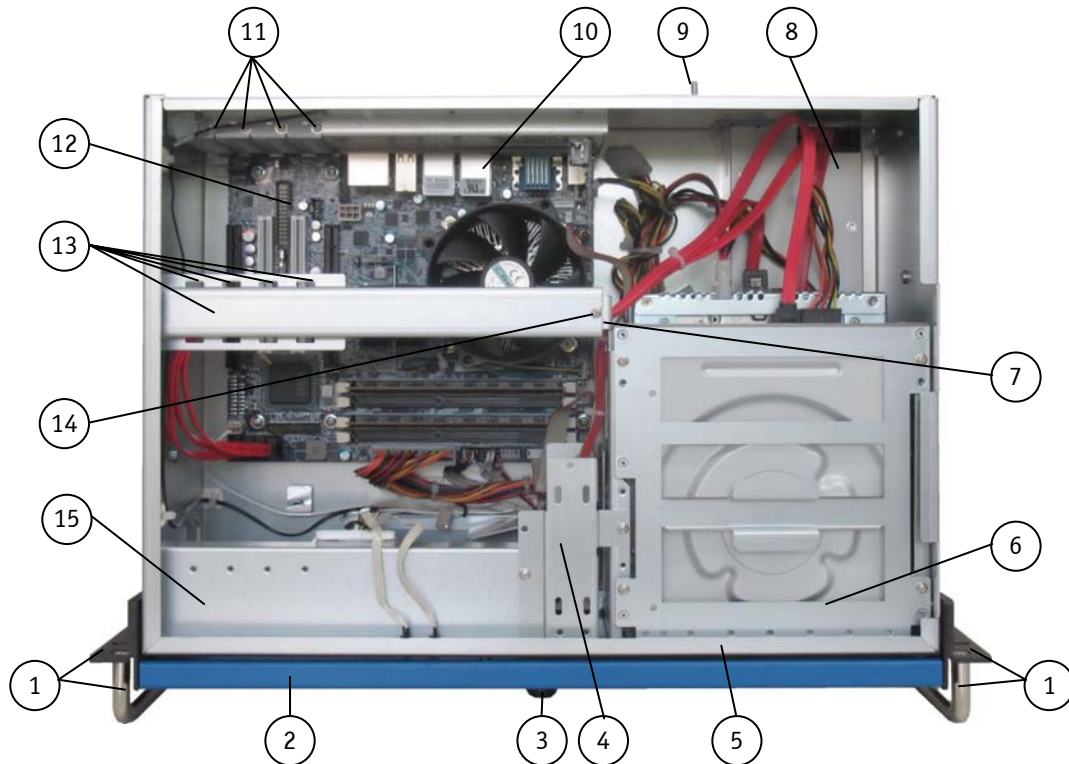

Fig. 6: KISS 4U Short V2, opened rackmount version (shown with a KTQ 45/Flex motherboard)

- |   |   |    |  |
|---|---|----|--|
| 1 | 19" rack mountable bracket with handle (not available for desktop version)  | 9  | Grounding stud   |
| 2 | Front access panel  | 10 | External interfaces of the motherboard                               |
| 3 | Lock for front panel security   | 11 | Slots for expansion cards  |
| 4 | Drive bracket for a 3.5" drive bay ( <b>L4</b> )                            | 12 | Motherboard  |
| 5 | Cover retaining bracket on the front side                                   | 13 | Card hold down bracket   |
| 6 | <b>L1, L2 and L3:</b> Drives (mounted on top of each other in a drive cage) | 14 | Fastening screw for the card hold down bracket (internal accessible) |
| 7 | Mounting bracket for the card hold down bracket                             | 15 | Fan compartment  |
| 8 | AC power supply unit  |    |  |

## 7.1. Front Side

The KISS 4U Short V2 platform will be delivered as rackmount version.

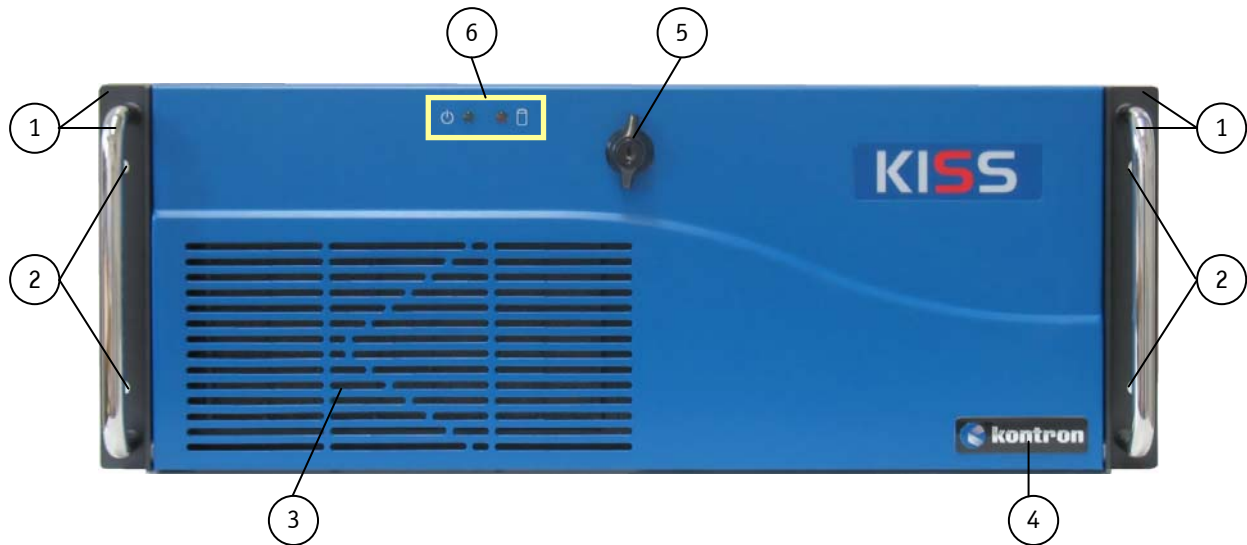
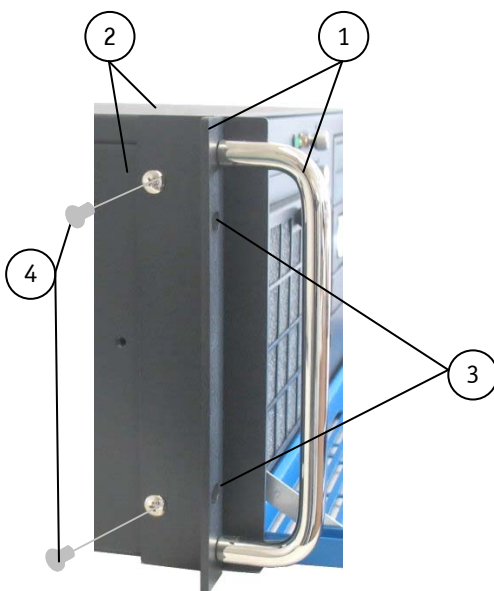

Fig. 7: Front side (rackmount version) with closed front access panel

- |  |   |
|--|---|
| 1 19" handle bracket                   | 4 Kontron Logo                                      |
| 2 Holes for mounting in 19" racks      | 5 Securing lock mechanism                           |
| 3 Air grille on the front access panel | 6 Light diffusers for the HDD LED and the power LED |

You can convert your rackmount system to a desktop unit by removing the two handle brackets (one handle bracket on each side).



- |  |
|--|
| 1 19" handle bracket                           |
| 2 Chassis and cover of the KISS 4U V2 platform |
| 3 Holes for mounting in 19" racks              |
| 4 Fastening screws of the 19" handle bracket   |

For desktop version the rubber feet are included.

To attach the rubber feet, please follow the instructions in chapter 8.1 "Attaching the Rubber Feet".

Fig. 8: 19" Handle bracket with fastening screws



The power button, the power/HDD activity LEDs, 2x USB interfaces, 1x filter mat holder and the integrated drives are located at the front side of the KISS 4U Short V2 platform behind the access panel.

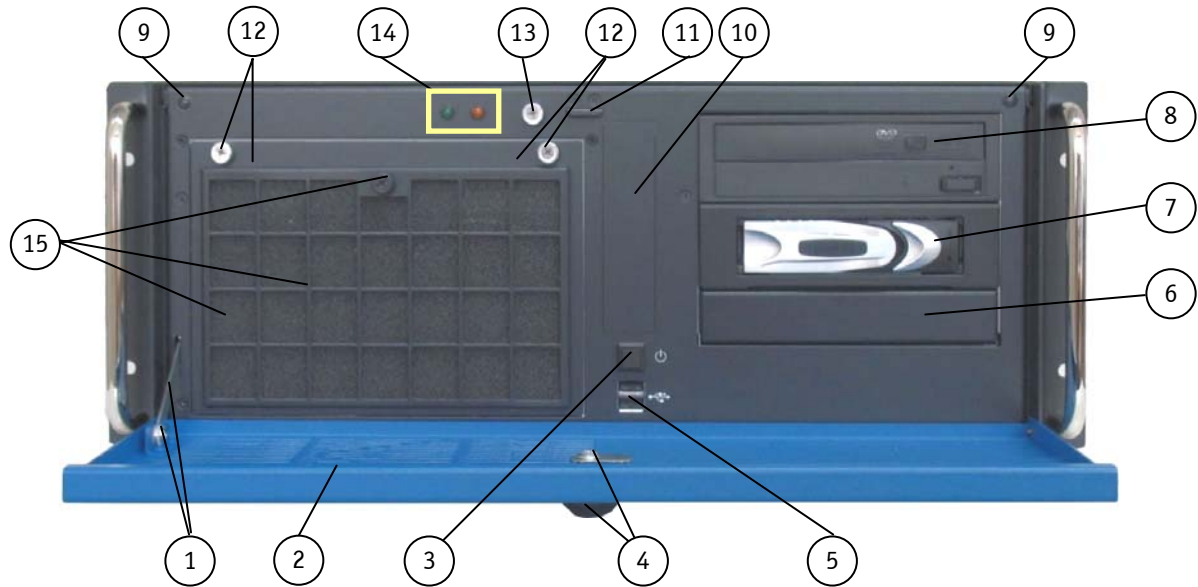

Fig. 9: Front side (rackmount version) with opened access panel

- |   |   |
|---|---|
| 1 Access panel holder   | 8 <b>L1</b> : front accessible 5.25" drive bay (shown with a DVD drive installed)                   |
| 2 Access panel  | 9 Buffer for the access panel   |
| 3 Power button  | 10 <b>L4</b> : front accessible 3.5" drive bay (without installed drive; shown with covering plate) |
| 4 Securing lock mechanism (two keys are provided)   | 11 Slot for the locking mechanism   |
| 5 2x USB 2.0  | 12 Fan slide-in module with knurled screws  |
| 6 <b>L3</b> : one internal 3.5" drive bay for an internal SATA HDD or for a front-accessible slim drive bay (shown with covering plate) | 13 Cover fastening screw on the front side  |
| 7 <b>L2</b> : front accessible 5.25" drive bay (shown with a KISS DA 135)   | 14 LED Indicators (Power LED, HDD activity LED)   |
|   | 15 Filter mat and filter mat holder with knurled screw  |

### 7.1.1. Interfaces on the Front Side

#### 7.1.1.1. USB Interfaces

The KISS 4U Short V2 platform is equipped with two USB interfaces on the front side (see Fig. 9, pos. 5 and Fig. 10, pos. 2). You can connect various USB devices to these two USB 2.0 interface connectors.

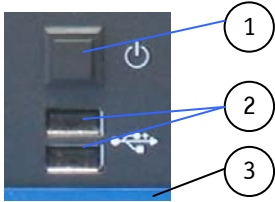

- 1 Power button
- 2 USB (2.0) ports
- 3 Access panel (detail)

Fig. 10: Power button and USB ports at the front side



When USB devices are connected to the USB ports on the front of the device, the front access panel cannot be closed and locked.

### 7.1.2. Controls and LED Indicators

#### 7.1.2.1. Power Button

The power button (see Fig. 9, pos. 3 and Fig. 10, pos. 1) is located on the front side of the system, behind the front access panel. Press this button to turn the system on or off. Please observe the setting options for the power button in the BIOS-Setup.



#### Caution!

Even when the system is turned off via the power button (Fig. 9, pos. 3 and Fig. 10, pos. 1) there is still a standby-voltage of 5 V<sub>Sb</sub> on the motherboard.

#### Hint for system configuration with AC Wide Range PSU!

Please observe that the ON/OFF switch of the AC wide range PSU does not disconnect the platform from the mains power source. The unit is only completely disconnected from the mains when the power cord is disconnected either from the mains power source or the unit. Therefore, the power cord and its connectors must always remain easily accessible. The outlet of the AC power source must be located near to the device and be easily accessible.

**+24 V DC respectively -48 V DC PSU:** The ON/OFF switch of these PSUs (Fig. 17 and Fig. 18) is the disconnecting device for DC configurations of the KISS 4U Short V2 platform.



Please observe the settings for the option "Restore on AC Power Loss" in BIOS Setup. The standard configurations of KISS 4U Short V2 platform are delivered with the default setting.

### 7.1.2.2. Power LED and HDD Activity LED

The LED indicators (see Fig. 9, pos. 14) of the KISS 4U Short V2 platform are located on the front side, behind the front access panel.



- 1 Power LED
- 2 HDD activity LED

Fig. 11: Indicators on the front side

<b>Power LED (green)</b>	<p>This LED (Fig. 11, pos. 1) lights up green when the system is turned on by the On/Off switch of the power supply unit.</p> <p><b>Prerequisite:</b> The system must be connected to the corresponding AC/DC power source, using the power cable. The power supply ON/OFF switch (if available), on the rear of the system must be set to "ON".</p>
<b>HDD LED (orange)</b>	<p>This LED (Fig. 11, pos. 2) lights up during hard disk activity.</p>

### 7.1.3. Front Access Panel

The securing lock mechanism (Fig. 7, pos. 5 and Fig. 9, pos. 4) located at the access panel allows you to protect your system from unauthorized use. When the access panel is locked, the cover of the KISS 4U Short V2 system can not be removed, and the drives, filter mat holder and power button are not accessible.



The key should be kept somewhere where it is not accessible to unauthorized persons.

If USB devices are connected to the USB ports on the front of the device, the front access panel cannot be closed and locked.

### 7.1.4. Cover fastening screw on the front side

The cover fastening screw (Fig. 9, pos. 13) secures the cover to the chassis on the front side.



To remove the cover of the KISS 4U Short V2 platform, the following knurled screws have to be loosened:

- the cover fastening screw (Fig. 9, pos. 13 and Fig. 24) on the front side
- the knurled screws (Fig. 12, pos. 8 and Fig. 25) on the rear side

To close the chassis of the KISS 4U Short V2 platform properly, the cover has to be attached and the abovementioned screws have to be fastened.

### 7.1.5. Filter Mat and Filter Mat Holder

The filter mat and the filter mat holder (Fig. 9, pos. 15) are located behind the air grilles of the front access panel (Fig. 7, pos. 3). The filter mat holder is mounted to the fan slide-in module (Fig. 9, pos. 12) via a knurled screw (Fig. 34, pos. 5) and two positioning latches (Fig. 34, pos. 6). A filter mat is inserted in the filter mat holder (refer to Fig. 35 and Fig. 36). This filter mat protects your system against dust and dirt (see chapter 10.1 "Cleaning the Filter Mat").

### 7.1.6. Fan Slide-in module

The two system fans are integrated in a user-friendly, replaceable fan slide-in module (hot-swap) (see chapter 8.3 “Fan Slide-in Module and Temperature Sensor”). The fan slide-in module (Fig. 9, pos. 12) can be replaced during operation (see chapter 10.2 “Replacing the System Fans”).

### 7.1.7. Drive Bays

Depending on the ordered system configuration, your system can be equipped with up to three drives on the front side and one internal drive (see Fig. 9, pos. 6, 7, 8 and 10):

Drive Bay	Description (refer to Fig. 9)
L1	Externally accessible 5.25" drive bay (shown with a DVD drive installed)
L2	Externally accessible 5.25" drive bay (shown with a KISS DA 135)
L3	One 3.5" drive bay for a internal SATA HDD or for a front accessible slim-line drive bay (shown with an internal, not externally accessible HDD installed)
L4	Externally accessible 3.5" drive bay (shown with covering plate)



For KISS 4U Short V2 system configurations with a disk subsystem with three HDDs (KISS DA 335), the drive bays L1, L2 and are occupied by this subsystem with removable HDDs.

For customer-specific versions and system configurations, please refer to the corresponding “KISS 4U Short V2 Systems - Configuration Guide” for KISS 4U Short V2 on our website [www.kontron.com](http://www.kontron.com).

### 7.2. Rear Side

Depending on the KISS 4U Short V2 platform configuration ordered, the rear panel will have the external interfaces of the integrated motherboard, any additional interfaces, the power supply unit and the air exhaust openings.

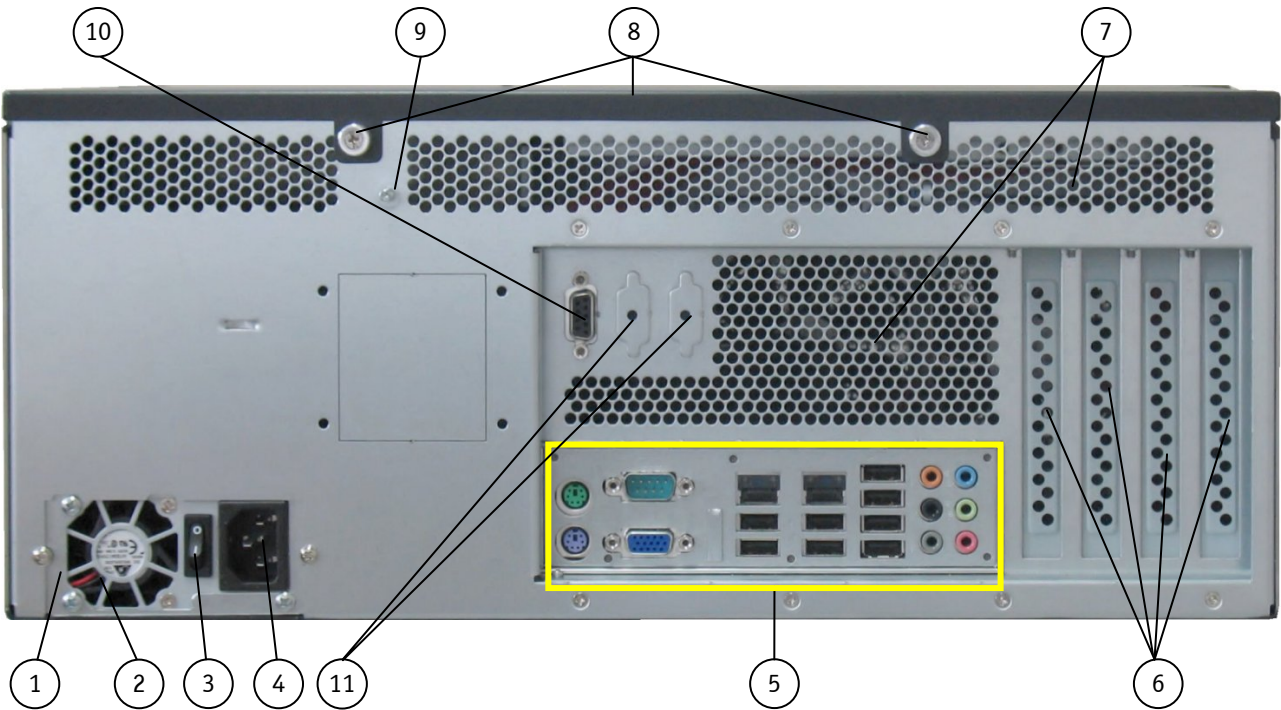

Fig. 12: Rear side of a KISS 4U Short V2 platform (shown with KTQ45/Flex motherboard)

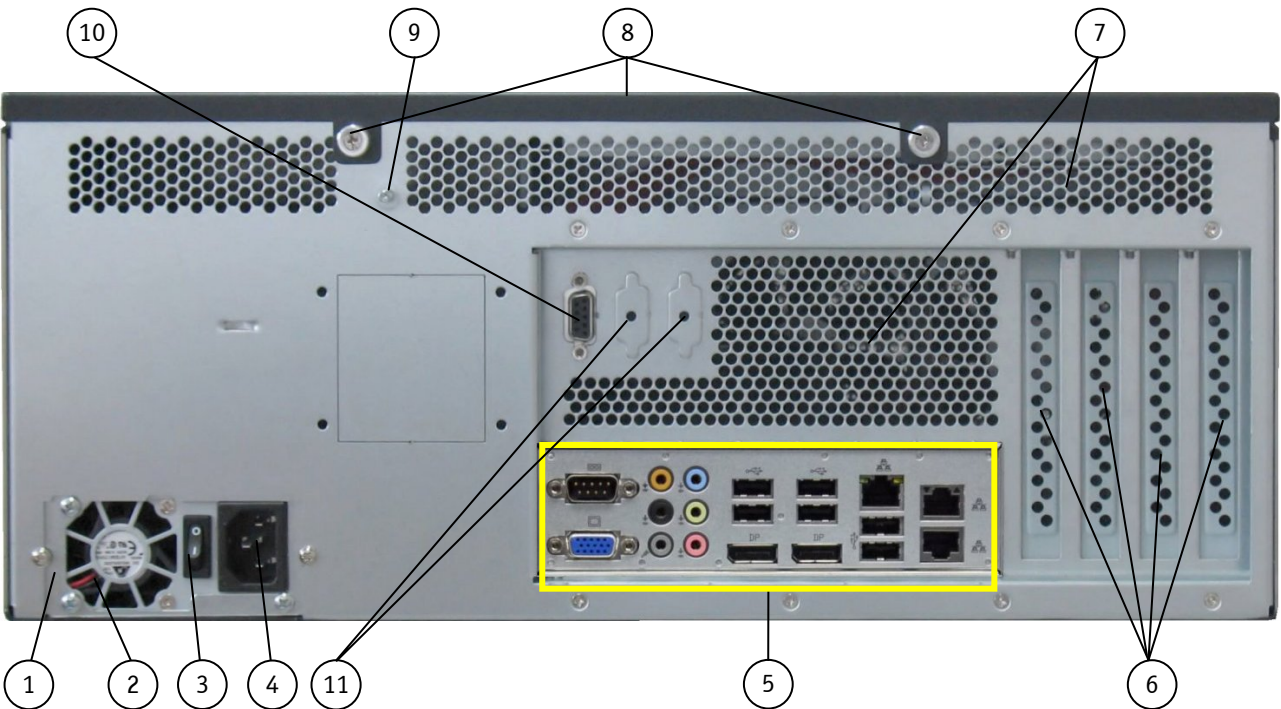

Fig. 13: Rear side of a KISS 4U Short V2 platform (shown with KTQ67/Flex motherboard)

**Legend for Fig. 12 and Fig. 13:**

- |   |   |
|---|---|
| 1 AC power supply unit (PSU)  | 6 Free expansion card slots   |
| 2 Power supply fan  | 7 Air exhaust openings  |
| 3 "On/Off" switch of the PSU ( <b>it does not disconnect the system from the mains power source</b> ) | 8 Rear side of the cover with captive knurled screws  |
| 4 AC input connector  | 9 Grounding stud  |
| 5 Interfaces of the or motherboard  | 10 Optional serial interface (RS232) routed to the rear panel                                 |
|   | 11 Cut-outs for optional (customer-specific) interfaces routed to the rear (9-pin D-SUB type) |

**7.2.1. Interfaces on the Rear Side**

The positioning and number of the KISS 4U Short V2 platform interfaces may vary depending on the system configuration.

Information and technical data can be found in the corresponding board manual of the installed motherboard.

You can download the relevant board manual for your system from our web site at [www.kontron.com](http://www.kontron.com) by selecting the product name.

**7.2.1.1. External Interfaces of the KTQ45/Flex Motherboard**

A detailed ports description can be found in the manual of the installed motherboard. You can download the corresponding manual from our web site [www.kontron.com](http://www.kontron.com) by selecting the product.

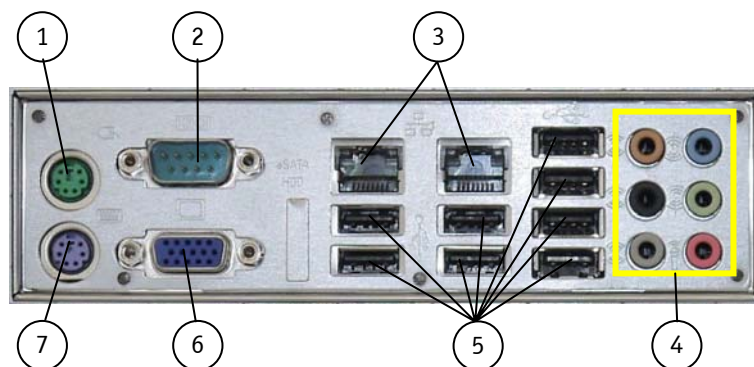

Fig. 14: External ports of the KTQ45/Flex motherboard

- |   |                               |
|---|-------------------------------|
| 1 PS/2 mouse port (green)                         | 4 Audio connectors (6.1)      |
| 2 Serial port (RS232)                             | 5 6x USB(2.0) ports           |
| 3 2x Ethernet ports (RJ45),<br>(10/100/1000 Mbps) | 6 VGA port                    |
|   | 7 PS/2 keyboard port (purple) |

### 7.2.1.2. External Interfaces of the KTQ67/Flex Motherboard



A detailed ports description can be found in the manual of the installed motherboard. You can download the corresponding manual from our web site [www.kontron.com](http://www.kontron.com) by selecting the product.

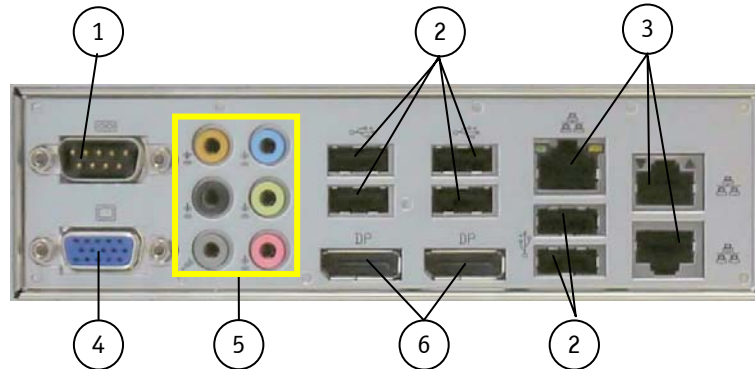

Fig. 15: External ports of the KTQ67/Flex motherboard

- |  |                          |
|--|--------------------------|
| 1 Serial port (RS232)                          | 4 VGA port               |
| 2 6x USB (2.0) ports                           | 5 Audio connectors (6.1) |
| 3 3x Ethernetport (RJ45),<br>(10/100/1000Mbps) | 6 Display Port (DP)      |

### 7.2.1.3. Interfaces routed to the Rear Panel

The on-board serial interface is routed to the rear panel or your system can be extended with an additionally ordered EASY 485/422 module (refer to Fig. 12 and Fig. 13, pos. 10). You can connect peripheral devices to these connectors.



You can download the relevant CPU card manual for your system configuration from our web site at [www.kontron.com](http://www.kontron.com) by selecting the product. See also "KISS 4U Short V2 Systems - Configuration Guide" on our website.

### 7.2.2. Power Supply Unit and PSU Switch

The power supply is located on the rear side of the KISS 4U Short V2 platform.

On request, the KISS 4U Short V2 platform can optionally be equipped with either an AC wide range, a +24VDC or a -48VDC power supply unit. The respective power supply version and the corresponding nominal voltage range can be found on the type label on the right side of the system.

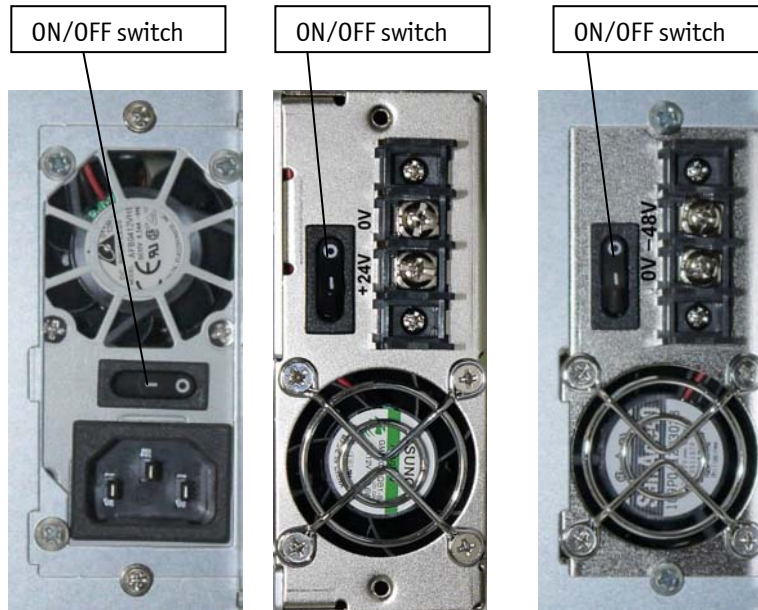

Fig. 16: Detail:  
AC Wide Rang PSU

Fig. 17: Detail:  
+24VDC PSU

Fig. 18: Detail:  
-48VDC PSU



Please observe the settings for the option “Restore on AC Power Loss” in BIOS Setup. The standard configurations of KISS 4U Short V2 platform are delivered with the default setting.



#### Hint for System configuration with AC wide range PSU!

Please observe that the ON/OFF switch of the AC wide range PSU (Fig. 16) does not disconnect the KISS 4U Short V2 platform from the mains power source. Even you turn off the system via the power button (Fig. 9, pos. 3 and Fig. 10, pos. 1) or via the ON/OFF switch (Fig. 12, pos. 3) of the PSU there is still a standby-voltage of 5 V<sub>Sb</sub> on the motherboard.



#### Hint for system configuration with DC PSU!

After attaching the cables to the terminals of the DC PSU, always operate the KISS 4U Short V2 systems with the protective cover available.



### 7.2.3. Grounding Stud

The grounding stud is located on the rear side of the KISS 4U Short V2 platform (Fig. 12 and Fig. 13, pos. 9).



The KISS 4U Short V2 systems with marked grounding studs with a PE symbol have to be grounded by establishing a large-area contact between the grounding stud and an appropriate grounding connection point.



*Fig. 19: Grounding stud marked with PE symbol*



*Fig. 20: Unmarked grounding stud*

### 7.3. Side View

Four M4 metric tapped holes are available at the left and right side of the unit (Fig. 21, pos. 2). These can be used in order to attach slide rails or corresponding L brackets (not included) to the KISS 4U Short V2 platform for system installation into a 19" industrial cabinet.

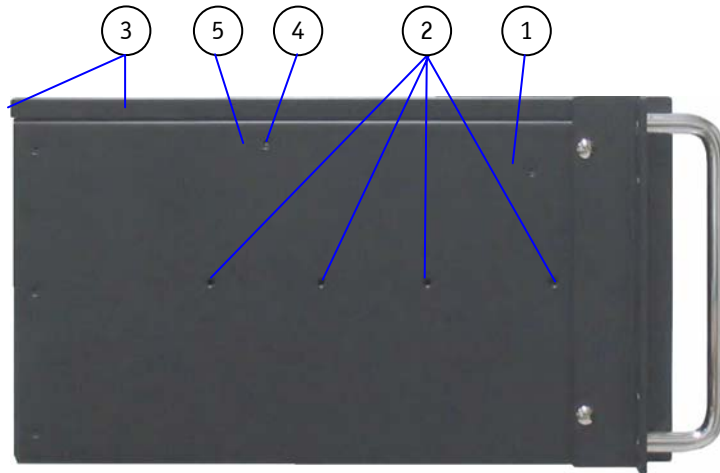

Fig. 21: KISS 4U Short V2 platform – side view

- |   |   |   |  |
|---|---|---|--|
| 1 | Right side view of a KISS 4U Short V2 platform                            | 4 | Externally accessible screw (countersunk screw M3x6) for fastening the card hold down bracket for long expansion cards |
| 2 | 4x M4 tapped holes (on both sides)  |   |  |
| 3 | Cover with captive knurled screws (for securing the cover to the chassis) | 5 | Internal bolt for the card hold down bracket for expansion cards   |

## 8. Assembly, Disassembly

### 8.1. Attaching the Rubber Feet

The rubber feet can be used for the desktop version of the system.

To attach the rubber feet to the bottom side of the chassis, please perform the following steps:

1. Turn your system off and disconnect it from the main power supply (please observe the instruction included in the subsection 7.2.2 "Power Supply Unit and PSU Switch").
2. Make sure that all cards are secured into unit and that the system cover is installed and secured.
3. Turn the system upside down.
4. Remove the protective film from the self adhesive rubber feet.
5. Attach the self adhesive rubber feet to the bottom side of the chassis.

### 8.2. Device Cover

The cover will be fixed to the chassis using two fixing brackets at the front side of the cover (Fig. 22, pos.3 and pos. 4), two fixing brackets with captive knurled screws at the rear side of the cover (Fig. 22, pos.6) and the cover fastening screw (Fig. 9, pos. 13) at the front side of the KISS 4U Short V2 platform.

When closing the cover, make sure that the fixing latches (Fig. 22, pos.3 and pos. 4) are inserted properly into the corresponding retaining bracket of the chassis (Fig. 6, pos. 5). The centering latch (Fig. 22, pos. 3) and the front cover fastening screw (Fig. 9, pos. 13) secure the cover on the front side.

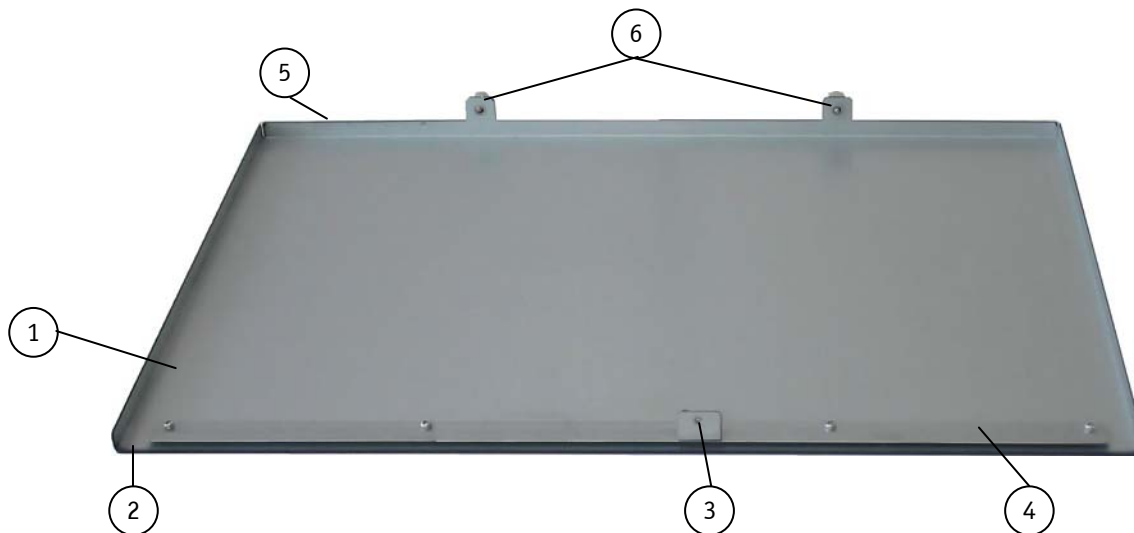

Fig. 22: Inside of the cover with fixing brackets

- |  |   |
|--|---|
| 1 Inside of the device cover                                     | 4 Fixing latch (on the front side)                      |
| 2 Front part of the cover  | 5 Rear part of the cover                                |
| 3 Angulated centering latch with tapped hole (on the front side) | 6 Fixing latches with knurled screws (on the rear side) |

### 8.3. Fan Slide-in Module and Temperature Sensor

The two system fans (Fig. 23 and Fig. 42, pos. 3) are integrated in a user-friendly, replaceable fan slide-in module (hot-swap). The fan slide-in module is mounted in a fan compartment on the front side of the system (Fig. 41, pos, 5). The system fans are temperature controlled via the temperature sensors installed in the KISS 4U Short V2 platform. Thus, a reliable air circulation for optimal active cooling of the platform is guaranteed.

The temperature conditions of the system (depending on the environmental temperature and the system load) are detected by two temperature sensors. One temperature sensor is located in the rear part (near the ventilation openings) and the second sensor is placed sideways in the mid part of the KISS 4U Short V2 platform.

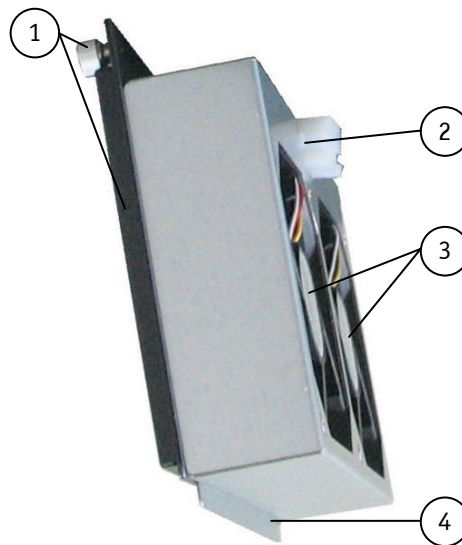

Fig. 23: Fan slide-in module

- |   |  |
|---|--|
| 1 Fan slide-in module with two knurled screws | 3 2x fans (temperature controlled independently from each other) |
| 2 Connector for fan control                   | 4 Bracket of the fan slide-in module                             |



The operation of the KISS 4U Short V2 platform is permitted only with a functional fan slide-in module!

Defective components may only be replaced by Kontron original spare parts.

- "fan slide-in module", part number: 1035-6968

#### Important Instructions!

The fan slide-in module can be replaced during operation. This should only be carried out by qualified personnel aware of the associated dangers (see chapter 10.2 "Replacing the System Fans").

## 8.4. Accessing Internal Components

This chapter contains important information on working safely with internal components. Please follow these instructions when handling cards or replacing system fans.

### 8.4.1. Installing/Removing the Expansion Cards



When you install (or remove) expansion cards please consider the corresponding safety instruction included in chapter 4 and the provided document "General Safety Instruction for IT Equipment".

Activities such as working inside the system or handling the expansion cards have to be carried-out by qualified personnel for this area.

Before removing the device cover, ensure that your system is switched off and disconnected from the mains power supply.

#### Caution:

**Energy hazards > 240 VA are present inside the chassis!**

**Activities such as system expansion with expansion cards, or maintenance have to be carried-out by qualified personnel familiar with the associated dangers!**

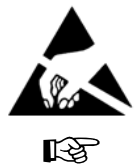

Please follow the safety instructions for components that are sensitive to electrostatic discharge (ESD). Failure to observe this warning notice can result in damage to the device.

Please consult the documentation provided by the manufacturer of the expansion card for instructions before attempting to install/remove an expansion card into/from your system.

To install or remove an expansion card, perform the following steps:

1. Turn your system off and disconnect it from the AC mains power source.



In order to remove the cover, following knurled screws have to be loosen:

- the cover fastening screw (Fig. 9, pos. 13 and Fig. 24) on the front side
- the knurled screws (Fig. 12, pos. 8 and Fig. 25) on the rear side.

2. Loosen the knurled screws (the cover fastening screw on the front side and the two knurled screws on the rear side) which secure the cover (see Fig. 24 and Fig. 25).



Fig. 24: Lösen der Deckel-Anziehschraube an der Frontseite



Fig. 25: Lösen der Rändelschrauben an der Rückseite

3. Pull the cover out a little bit (Fig. 26) to release the cover centering and fixing latches (Fig. 22, pos.3 and pos. 4) from the retaining bracket of the chassis (see Fig. 6, pos. 5).

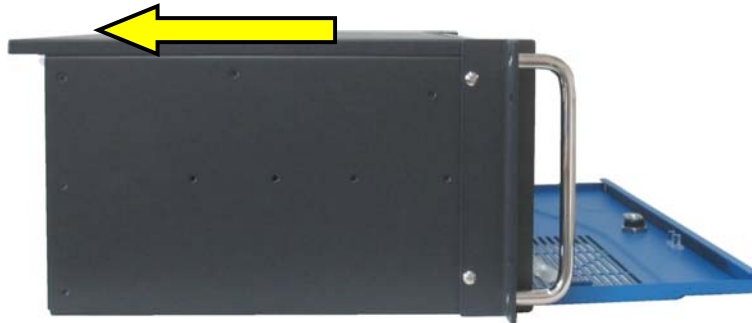

Fig. 26: Pull out the cover centering and fixing brackets from the retaining bracket of the chassis.

4. Lift the cover up (on the rear edge) and remove it (Fig. 27).



Fig. 27: Removing the cover

The card hold down brackets and a retaining bracket (Fig. 6, pos. 13 and Fig. 28) and a mounting bracket (Fig. 6, pos 7) secure the expansion cards to the corresponding expansion slots.



Fig. 28: Card hold down bracket for long expansion cards

- 1 Threaded holes for the externally accessible fastening screws (Fig. 21, pos. 4)
- 2 Holes for the internal bolts (Fig. 21, Pos. 5)
- 3 Notches for the fastening screws that secure the card hold down brackets to the internal mounting bracket (Fig. 6, pos 7)



Fig. 29: Opened KISS 4U Short V2 platform - removing the card hold down brackets

5. Loosen (as shown in the Fig. 29 step 1 and 2), the internal fastening screw (Fig. 6, pos. 14) that secures the card hold down bracket and the externally accessible fastening screw that secure the card hold down bracket to the chassis (Fig. 21, pos. 4). Pull the card hold down bracket to the left (Fig. 29, step 3) to detach it from the sideways internal mounted bolt. Lift the card hold down bracket out (Fig. 29, step 4). Put the card hold down bracket and the screws aside for later use.
6. Install/remove the expansion card into/out of the expansion slot of the motherboard and fasten the slot bracket or the expansion card bracket to the rear slot of the device.
7. Reinstall the card hold down bracket/s and secure it/them with the screws retained.
8. If required, mount the PCB holder to the corresponding positioning holes of the card hold down bracket using the provided screws. Fix the upper edge of the expansion card into the notch of the PCB holder (height adjustable). Thus the expansion card is firmly kept in place during high mechanical load (shock and vibrations).
9. In order to re-assemble the card hold down brackets, follow the steps in reversed order. Tighten the corresponding screws half way at first. Then, tighten firmly the externally accessible screws. Only then tighten firmly the screws at the notch that secure the card hold down bracket.
10. Close the KISS 4U Short V2 platform and secure the cover as described in the section 8.2 "Device Cover".



The chassis of the KISS 4U Short V2 platform with attached cover is properly closed only, if the following knurled screws are tightened:

- the cover fastening screw (Fig. 9, pos. 13 and Fig. 24) on the front side
- the knurled screws (Fig. 12, pos. 8 and Fig. 25) on the rear side.

## 8.5. Installation in a 19" Industrial Cabinet

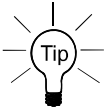

Expansion card installation should be performed before installing the KISS 4U V2 system into a 19" industrial cabinet.

Please consider the instructions described in the section 8.4 "Accessing Internal Components".

Before closing the industrial cabinet, you must connect your peripherals to the corresponding system ports.

For KISS 4U Short V2 versions and system configurations, please refer to the corresponding "KISS 4U Short V2 Systems - Configuration Guides" on our website [www.kontron.com](http://www.kontron.com). More information and technical data can be found in the corresponding board manual (motherboard depending on the system configuration ordered). You can download the manual from our web site at [www.kontron.com](http://www.kontron.com) by selecting the product.



In order to setting-up installing / removing the KISS 4U V2 platform into/from a 19" industrial cabinet, please observe the instructions described in this manual.

Please consider the corresponding safety instruction included in chapter 4 and the supplied document "General Safety Instruction for IT Equipment".

The system has to be mounted and installed only by qualified personnel for this area familiar with the associated dangers.

Please observe the instructions included in the subsection 7.2.2 "Power Supply Unit and PSU Switch".

Ensure there is sufficient air circulation around the device when installing the KISS 4U Short V2 platform.

The openings for air intake and exhaust on the device must not be obstructed by objects.

Leave at least 5 cm (1.969 ") of free space in front and behind the KISS 4U Short V2 platform to prevent the device from possibly overheating.

The KISS 4U Short V2 platform should be installed into a 19" industrial cabinet by use of slide rails or by use of corresponding L-rack mounting brackets (not available).

For the installation of the KISS 4U Short V2 platform in a 19" industrial cabinet, you can order from Kontron slide rails (PN: 1016-5807) and the "Rack Slide Rails Kit for KISS 1U and KISS 2U/4U" (PN: 1051-7200).

The KISS 4U Short V2 platform can be installed into a 19" industrial cabinet with slide rails or corresponding L brackets for rack mounting (not included).

The 19" industrial cabinet must stand firmly in place. You can improve its stability by placing the components into it from the bottom up. Heavy components should be placed down below.

If further stabilization is necessary, then bolt the 19" industrial cabinet to the floor or anchor it on the wall.

The voltage feeds must not be overloaded.

Adjust the cabling and the external overcharge protection to correspond with the electrical data indicated on the type label.

The type label is located on right side of the unit.



## 9. Starting Up



Please consider the corresponding safety instruction included in chapter 4 and the supplied document "General Safety Instruction for IT Equipment".

When used as intended the KISS 4U Short V2 platform is to operate only closed and locked.

When the cover is properly secured using the knurled screws on the rear and the cover fastening screw at the front, and front access panel is locked with the locking mechanism, it ensures that the user does not have access to the internal parts of the device loaded with hazardous energy.



The rated voltage of the mains (AC/DC) must agree with the voltage value on the type label.

### 9.1. AC Power Connection

The AC input connector is located at the rear side of the KISS 4U Short V2 system.



#### Hint for system configuration with AC Wide Range PSU!

Please observe that the ON/OFF switch of the AC wide range PSU (unit does not disconnect the platform from the mains power source).

Even when the system is turned off via the power button (Fig. 9, pos. 3 and Fig. 10, pos. 1) or via the ON/OFF switch (Fig. 12, pos. 3) of the power supply unit, there is still a standby-voltage of 5 VS<sub>b</sub> on the motherboard.

The unit is only completely disconnected from the mains when the power cord is disconnected either from the mains power source or the unit. Therefore, the power cord and its connectors must always remain easily accessible.

The outlet of the AC power source must be located near to the device and be easily accessible.



Please observe the settings for the option "Restore on AC Power Loss" in BIOS Setup.

The standard configurations of KISS 4U Short V2 platform are delivered with the default setting.



Fig. 30: KISS 4U Short V2, rear side without PE marked grounding stud

To connect the KISS 4U Short V2 platform to an AC power supply, perform the following steps:

1. The KISS 4U Short V2 systems with grounding studs marked with a PE symbol have to be grounded by establishing a large-area contact between the grounding stud (at the rear side) and an appropriate grounding connection point (see subsection 7.2.3 Grounding Stud", Fig. 19 and Fig. 20).
2. Connect the AC power cord to the AC input connector.
3. Connect the other end of the AC power cord to a corresponding mains power source outlet.



Make sure that the power supply (power outlet) is properly grounded and that the power cord is in perfect condition without any visible damage. An ungrounded power supply is not permissible.

## 9.2. DC Power Connection

The DC version of the KISS 4U Short V2 platform is equipped with a +24V or -48V power supply (with a 2-pin terminal block and an ON/OFF power switch)



It must be ensured that the platform can be powered ON and OFF via an easy accessible two pole isolating switch and an overload protection. These should be incorporated in the building installation wiring. The unit is only completely disconnected from the DC power source, when:

- it is switched OFF via the ON/OFF switch of the DC PSU
- or
- the DC power cord is disconnected either from the power source or the unit. Therefore, the DC power cord and its connectors must always remain easily accessible.



Please ensure that during the DC connection procedure, there is no power flowing from the external DC power source to the KISS 4U Short V2 system.

### 9.2.1. Attaching the Ferrite Core



Before you connect the KISS 4U Short V2 with DC Power Supply Unit (PSU) to a DC power source, you have to attach the ferrite core (7427113, manufacturer: Würth Elektronik) to the wires that are used for the power connection:

- 2x 2x wires with a minimum cross section of 2.5 mm<sup>2</sup> for the +24VDC PSU
- 2x wires with a minimum cross section of 1.5 mm<sup>2</sup> for the -48VDC PSU

Only with the attached ferrite core are ensured the requirements of EMC standards (for emission and immunity).

Do not close the ferrite core before you have attached it to the power wires!

To attach the ferrite core, proceed as follows:

1. Open the ferrite core as much as possible.
2. Put the two wires together.
3. Lay the wires into the middle channel of the one half of the ferrite core, at 5-8 cm (2-3 in) to one end of the wires. Run the wires lengthwise, one time around the ferrite core (*see figure below*), so that the wires are running out at the other end of the ferrite core.
4. Fold the two halves of the ferrite core, without closing the ferrite case completely.
5. Check the location of the wires in the channel of the ferrite core. If the winding loop is too large, you have to reduce it, by pulling the end of the longer wires.
6. Close the ferrite core completely until the clamp snaps in place.

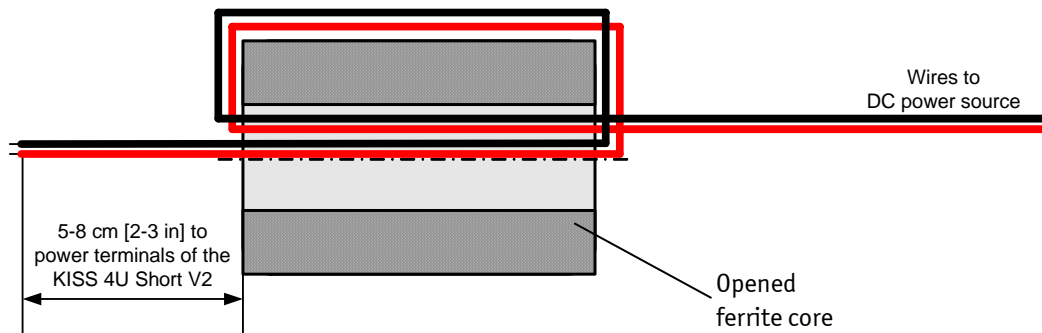

Fig. 31: Opened ferrite core with wires

### 9.2.2. DC Power Cord Connection



Please ensure that during the DC connection procedure, there is no power flowing from the external DC power source to the KISS 4U Short V2 system.

1. Prepare two isolated wires (minimum cross section of 2.5 mm<sup>2</sup> for the +24VDC PSU and minimum cross section of 1.5 mm<sup>2</sup> for the -48VDC PSU) with attached ferrite core (refer to the subsection 9.2.1 “Attaching the Ferrite Core”), according to the connectors of the screw terminal.
2. Loosen the two cross-head screws of the screw terminal so that you can insert the stripped ends of the wires. Pay attention to the polarity of the wires.
3. Fasten the cross-head screws firmly.
4. Cover the connectors of the screw terminal with the protective cover available.



After attaching the cables to the terminals of the DC PSU (+24VDC or -48VDC) always operate the DC versions of KISS 4U Short V2 systems with the protective cover provided.

5. Prepare the other ends of the wires according to the terminal of the DC power source.
6. Connect the wires prepared to the DC power source. Pay attention to the polarity of the connectors. The DC power source has to be switched off.
7. Switch on the DC power source.

### 9.3. Operating System and Hardware Component Drivers

The KISS 4U Short V2 system can optionally be supplied with or without a pre-installed operating system.

If you have ordered your system with a pre-installed operating system, all drivers are installed, corresponding to the ordered computer configuration (optional hardware components). Your computer is fully operational, when you switch it on for the first time. Please observe the information below.



**Important information for using the pre-installed “WINDOWS 7 ULTIMATE FOR EMBEDDED SYSTEMS” or “WINDOWS 7 PROFESSIONAL FOR EMBEDDED SYSTEMS” operating systems:**

The terms and condition for using the pre-installed operating systems are defined in the document „MICROSOFT SOFTWARE LICENSE TERMS“.

This document can be downloaded from our web site [www.kontron.com](http://www.kontron.com) by selecting the product name/tab Downloads/Windows.

If you have ordered KISS 4U Short V2 without a pre-installed operating system, you will need to install the operating system and the appropriate drivers for the system configuration you have ordered (optional hardware components) yourself.



You can download the relevant drivers for the installed hardware from our web site at [www.kontron.com](http://www.kontron.com) by selecting the product.

Consider the manufacturer's specifications for the operating system and the integrated hardware components.

## 10. Maintenance and Prevention

Equipment from Kontron Europe requires only minimum servicing and maintenance for problem-free operation.

- For light soiling, clean the KISS 4U Short V2 with a dry cloth.
- Stubborn dirt should be removed using a mild detergent and a soft cloth.
- Clean the filter mat regularly (see chapter 10.1 "Cleaning the Filter Mat").

### 10.1. Cleaning the Filter Mat

The filter mat is inserted in the filter mat holder at the front side of the fan slide-in module (Fig. 32, pos. 4). The soiling of the filter mat is caused by the pollution of the operating environment. A heavily soiled filter mat can cause excessive heating of the device. For this reason we recommend to clean the filter mat as often as necessary. The filter mat can be changed during operation of the system.

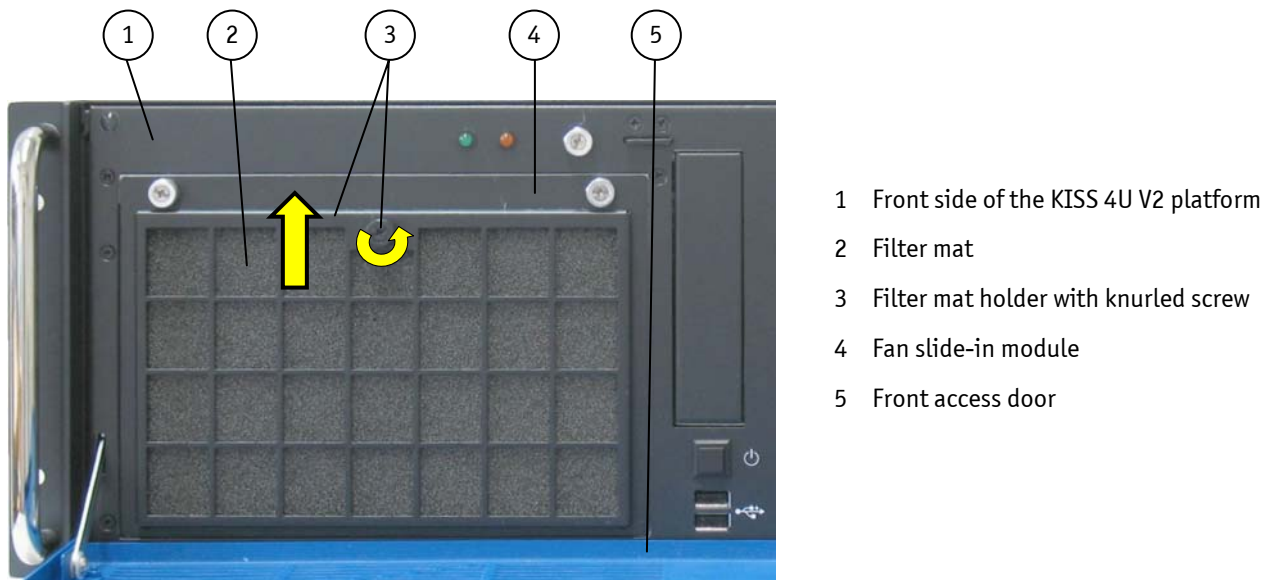

Fig. 32: Detail: Filter mat holder on the front side of the KISS 4U Short V2 platform

To replace the filter mat, proceed as follows:

1. Open the front access panel (Fig. 32, pos. 5).
2. Loosen the knurled screw that secures the filter mat holder to the fan slide-in module (Fig. 32, pos. 4 and Fig. 34, pos. 5).
3. Pull the filter mat holder out of the positioning slots (Fig. 33, pos. 3) into the marked direction (see Fig. 32) and lift it off.
4. Remove the soiled filter mat (Fig. 32, pos. 2 and Fig. 36).
5. Clean the filter mat as follows:
  - Rinse in water (up to approx. 40°C; possibly with the addition of a standard mild detergent).
  - It is also possible to beat the filter pad, to vacuum it or blow it with compressed air.
  - For dirt that contains grease/oil, the filter pad should be rinsed with warm water with the addition of a degreaser. Filter pads should not be cleaned with powerful water jets or wrung out.

6. After cleaning and drying the filter pad, place it in the filter mat holder (see Fig. 35).
7. Reattach the filter mat holder to the front side of the fan slide-in module by inserting the positioning latches (Fig. 34, pos. 6) into the positioning slots (Fig. 33, pos. 3).
8. Fix the filter mat holder by tightening the knurled screw (Fig. 34, pos. 5) to the bolt with tapped hole (Fig. 33, pos. 1) at the fan slide-in module.



Defective components may only be replaced by Kontron original spare parts.

Air filter mat: part number: 1035-6957.

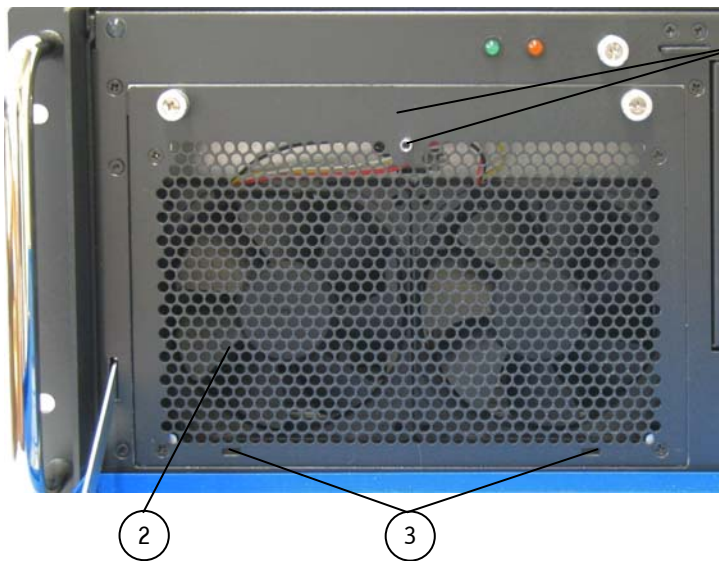

Fig. 33: Detail: without filter mat at the front side

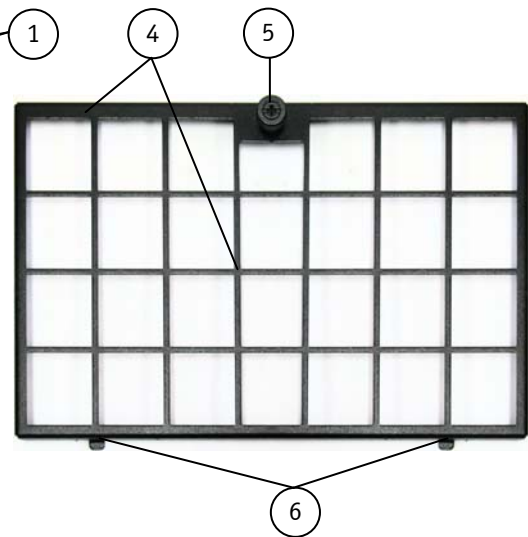

Fig. 34: Filter mat holder without filter mat



Fig. 35: Filter mat holder with filter mat

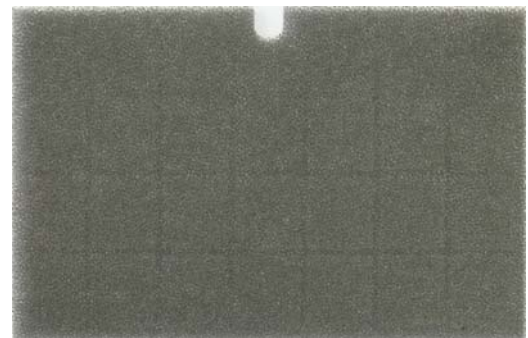

Fig. 36: Filter mat

#### Legend for Fig. 33 and Fig. 34:

- |  |  |
|--|--|
| 1 Fan slide-in module with bolt with tapped hole                   | 4 Filter mat holder                            |
| 2 Air intake openings at the front side of the fan slide-in module | 5 Knurled screw of the filter mat holder       |
| 3 Positioning slots for the filter mat holder                      | 6 Positioning latches of the filter mat holder |

### 10.1.1. Cleaning Steel Mesh Guard (for IP52 Protection Class only)

If you have ordered a KISS 4U Short V2 platform with IP52 Protection Class, the filter mat holder (Fig. 37) is fitted with an additional steel mesh guard (Fig. 38).

In order to remove the steel mesh guard, follow the steps 1 to 3 of the section 10.1 "Cleaning the Filter Mat".

Use a vacuum cleaner or compressed air to remove dust and debris from the steel mesh guard.

Reinsert the steel mesh guard (Fig. 38) and filter mat (Fig. 36) after cleaning into the filter mat holder (Fig. 34). The positioning of the protective guard and the filter mat in the filter mat holder is shown in Fig. 39.

Reattach the filter mat holder to the front side of the fan slide-in module as described in the section 10.1 "Cleaning the Filter Mat", step 7 and 8.



Fig. 37: IP52 - Filter mat holder with inserted steel mesh guard and filter mat

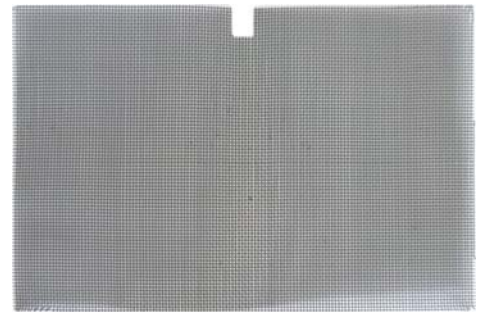

Fig. 38: Steel mesh guard

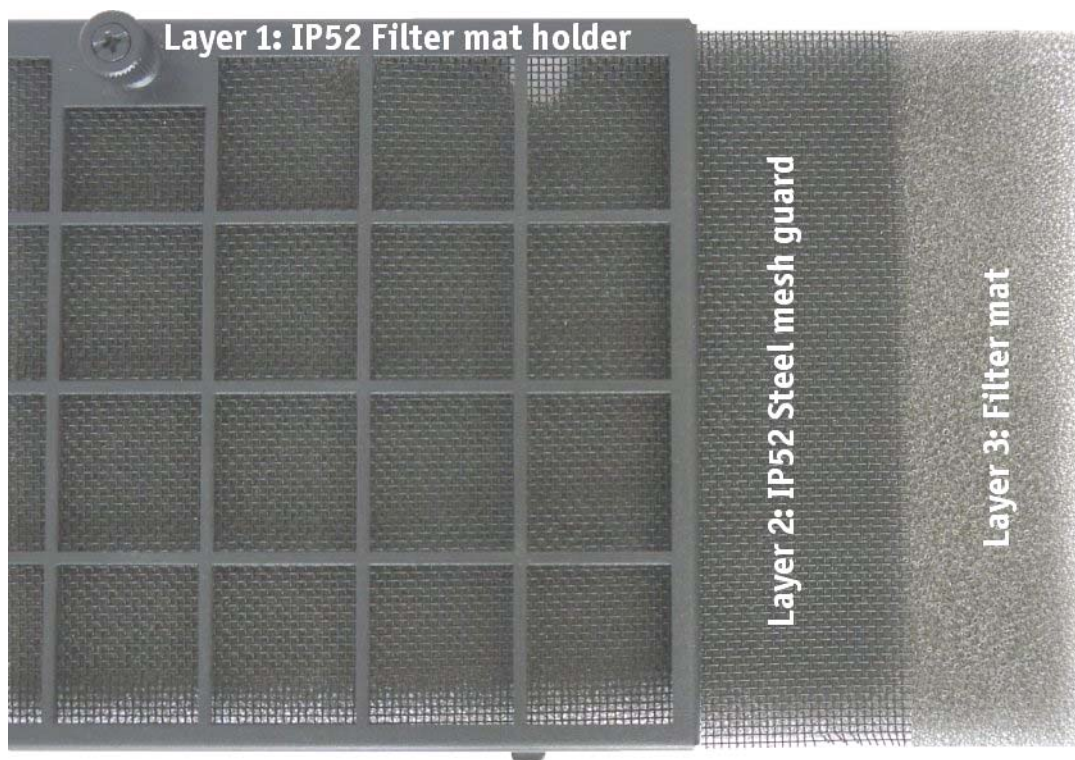



Fig. 39: IP52 variant - Positioning of the steel mesh guard and of the filter mat in the filter mat holder



The frontal IP52 protection class is ensured for the KISS 4U Short V2 platform only with an additional inserted steel mesh guard, and with closed front access panel.

## 10.2. Replacing the System Fans

	<p>The operation of the KISS 4U Short V2 system is permitted only with a functional fan slide-in module!</p> <p>Defective components may only be replaced by Kontron original spare parts.</p> <p>□ part number of the fan slide-in module: 1035-6968</p>
	<p>The fan slide-in module can be replaced during operation. This should only be carried out by a qualified specialist or a suitably instructed user, who is aware of the associated dangers.</p> <p>Keep your hands and fingers away from rotating parts of the fans. Before taking out the fan slide-in module, wait until the fans have totally stopped.</p>

To replace fan slide-in module, proceed as follows:

1. Remove the filter mat holder as described in section 10.1 "Cleaning the Filter Mat" (step 1 to 3) and put it aside for later reassembly.
2. Loosen the two knurled screws of the fan slide-in module (Fig. 40, pos 1)
3. Pull the fan slide-in module out of the cabinet using the knurled screws to disconnect it from the internal fan control socket (Fig. 41, pos. 4).
4. Lift the fan slide-in module as shown (Fig. 40, pos. 2) out of the fan compartment (see Fig. 41).

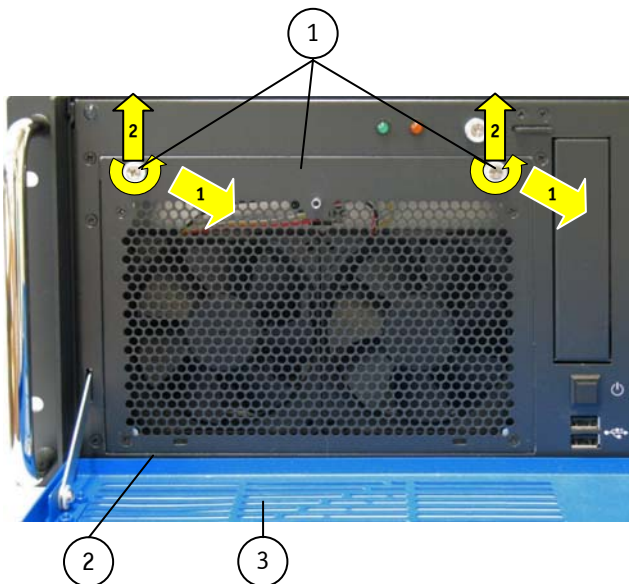

Fig. 40: Detail: Fan slide-in module without filter mat holder

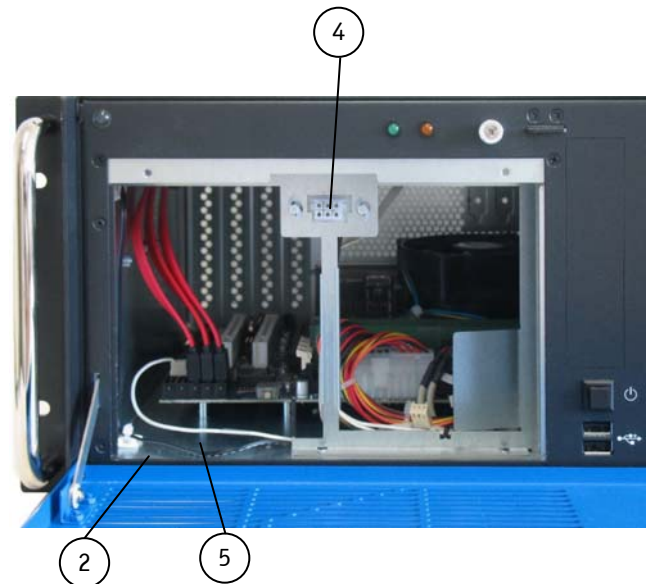

Fig. 41: Detail: Fan compartment (without fan slide-in module)

**Legend for Fig. 40 and Fig. 41:**

- |  |   |
|--|---|
| 1 Fan slide-in module with two knurled screws        | 3 Front access panel                      |
| 2 Fixing plate for the fan slide-in module (chassis) | 4 Socket for fan power supply and control |
|  | 5 Fan compartment                         |



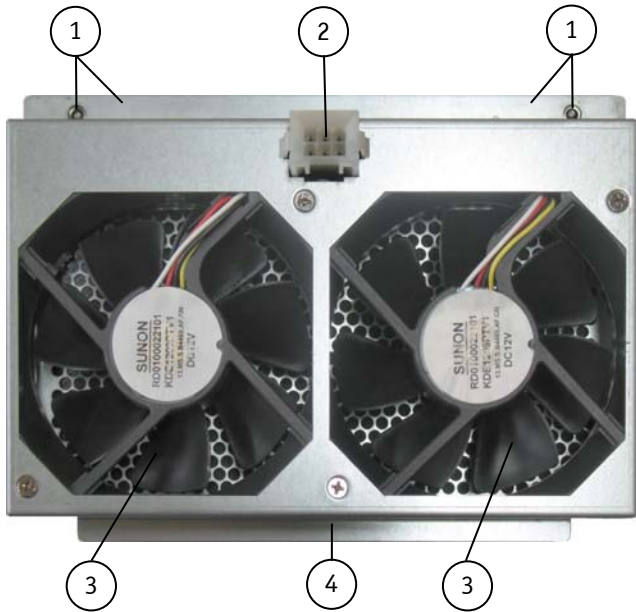

Fig. 42: Inner sider of the fan slide-in module

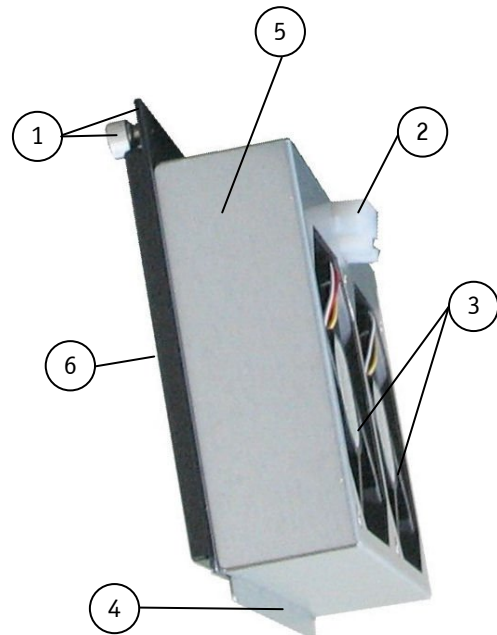

Fig. 43: Fan slide-in module with inserted filter mat

**Legend for Fig. 42 and Fig. 43:**

- |  |   |
|--|---|
| 1 Fan slide-in module with two knurled screws                    | 4 Positioning latch of the fan slide-in module                            |
| 2 Connector for fan control                                      | 5 Housing of the fan slide-in module                                      |
| 3 2x fans (temperature controlled independently from each other) | 6 Inserted filter mat holder at the front side of the fan slide-in module |

5. Replace the fan slide-in module with a new functional module.
6. Install the filter mat holder (put aside in step 1) with the filter mat to the front side of the fan slide-in module, as described in chapter 10.1 "Cleaning the Filter Mat" (step 7 and step 8; see also Fig. 43).
7. Insert the positioning latch (Fig. 42 and Fig. 43, pos. 4) into the fan compartment (Fig. 41, pos. 5) behind the fixing plate (Fig. 40 and Fig. 41, pos. 2).
8. After the positioning latch (Fig. 42 and Fig. 43, pos. 4) is properly inserted into the fan compartment, push the upper part of the fan slide-in module into the fan compartment until the fan control connector (Fig. 42, pos. 2) is firmly inserted into the socket (Fig. 41, pos. 4).
9. Secure the fan slide-in module by fastening the knurled screws.



If step 6 was skipped, the installation of the filter mat holder (with filter mat) has to be performed as the final step:

- Install the filter mat holder (put aside in step 1) with the filter mat to the front side of the fan slide-in module, as described in chapter 10.1 "Cleaning the Filter Mat" (step 7 and step 8).

### 10.3. Replacing the Lithium Battery

The integrated motherboard of your system is equipped with a lithium battery. To replace the battery, please proceed as follows:

1. Open the unit as described in chapter 8.4.1 "Installing/Removing the Expansion Cards" (step 1-4).

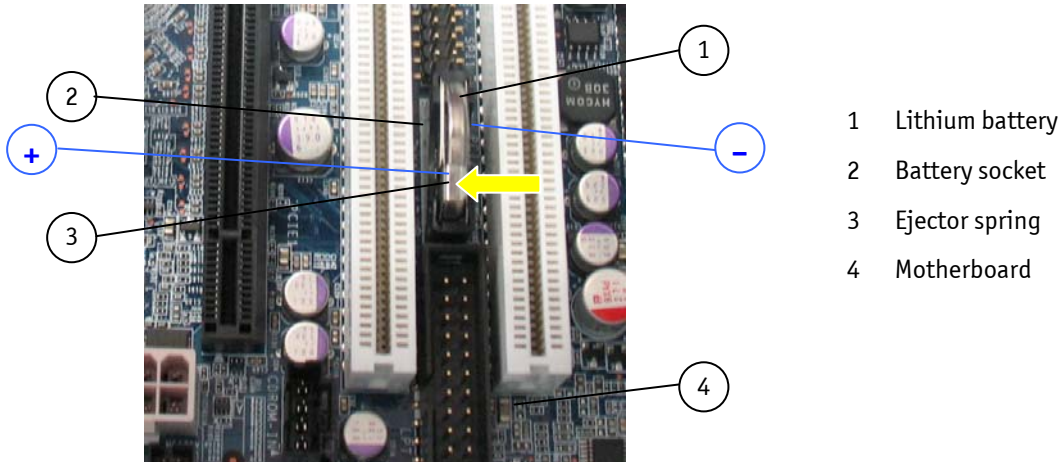

Fig. 44: Location of the Lithium Battery

2. If you have added expansion cards to your system, first remove the expansion cards plus all the corresponding connecting cables, to gain access to the lithium battery, following the instructions in chapter 8.4.1 "Installing/Removing the Expansion Cards" (step 5-7).
3. Remove the lithium battery from the holder by pulling the ejector spring outwards.
4. Place a new lithium battery into the battery holder.
5. Pay attention to the polarity of the battery; refer to Fig. 44.
6. The lithium battery must be replaced with an identical battery or a battery type recommended by Kontron Europe (Lithium battery 3.0 V for RTC, type: CR2032).
7. Reinstall the expansion cards which you removed and reconnect their data cables following the instructions in chapter 8.4.1 "Installing/Removing the Expansion Cards" (step 8-9).
8. Close the device, as described in chapter 8.4.1 "Installing/Removing the Expansion Cards" (step 10).



#### Caution

Danger of explosion when replacing with wrong type of battery. Replace only with the same or equivalent type recommended by the manufacturer. The Lithium battery type must be UL recognized.



Do not dispose of lithium batteries in general trash collection. Dispose of the battery according to the local regulations dealing with the disposal of these special materials, (e.g. to the collecting points for disposal of batteries).

## 11. Slide Rails (Option)

Kontron offers slide rails for installing the KISS 4U Short V2 platform into a 19" industrial cabinet. These can be ordered separately.



The KISS 4U Short V2 systems should be installed into a 19" industrial cabinet with slide rails (PN: 1016-5807). Use therefore the rack slide rails mounting kit for KISS 1U and KISS 2U/4U V2 systems (PN: 1051-7200).



Only the specified M4x6 screws should be used to attach telescope rails to the KISS 4U Short V2 platform.

## 12. Technical Data

KISS 4U Short V2-xxxxxxxx-y	
<b>Installed Board</b>	* See "KISS 4U Short V2 System - Configuration Guide"
<b>Interfaces</b>	I/O interfaces of the CPU card * See manual of the installed motherboard
<b>Drive BAYS</b>	Up to four drive bays * Optional equipment, depending on the system configuration ordered (see also "Configuration Guide")
<b>Free expansion Slots</b>	Up to 4 expansion slots * Optional equipment, depending on the system configuration ordered (see also "Configuration Guide")
<b>Lithium Battery</b>	* See manual of the installed motherboard
<b>Power Supply</b>	See type label



KISS 4U Short V2 = System type

The "xxxxxxxx" group is replaced by up to a max. 8-digit combination of numbers, letter or space, and represents the installed CPU board

The "y" is replaced by a single letter (A through Z) representing the power supply installed into the system.

The corresponding "KISS 4U Short V2 Systems - Configuration Guides" and the manual of the installed CPU board can be downloaded from our web site at [www.kontron.com](http://www.kontron.com) by selecting the product name.

### 12.1. Electrical Specifications

The electrical specifications of your KISS 4U Short V2 platform can be found on the type label.

## 12.2. Mechanical Specifications

Dimensions	KISS 4U Short V2
Height	4U (177 mm) (6.968 ")
Width	Front: 19" (482 mm); Chassis: 430 mm (16.9")
Depth	Chassis: 301 mm (11.85")
Weight (without Packaging)	Approx. 13 kg (28.66 lbs.)
Chassis	Chassis, black (RAL 7021) Front access panel, blue (RAL 5017)

## 12.3. Environmental Specifications

Thermal Management	2x System fan, temperature controlled (fan slide-in module) 1x CPU fan 1x PSU fan
Operating Temperature	0 ... +50 °C (+55 °C at 10% POH per month) 32 ... 122 °F (131 °F at 10% POH per month)
Storage / Transit Temperature	-20 ... +70 °C (-4 ... 158 °F)
Relative Humidity (Operation/Storage/Transit)	10-95 %, @ 40 °C non condensing
Max. Operation Altitude	2,000 m (6562 ft)
Max. Storage/Transit Altitude	10,000 m (32810 ft)
Operating Shock	15 G, 11 ms, half sine
Storage/Transit Shock	30 G., 11 ms, half sine
Operating Vibration	10 – 500 Hz, 1.0 G
Storage/Transit Vibration	10 – 500 Hz, 2.0 G
Acoustic Noise	< 35 dB(A) at 1 m in front of the system
Protection Class	Front: IP20; optional IP52

## 12.4. CE Directives and Standards

CE Directive	
<b>Elektrical Safety</b>	General Product Safety Directive (GPSD) 2001/95/EC Low Voltage Directive (LVD) 2006/95/EC
<b>Electromagnetic Compatibility (EMC)</b>	EMC Directive 2004/108/EC
<b>CE Marking</b>	CE Directive 93/68/EEC

<b>Elektrical Safety</b>	<b>Harmonized Standards</b>
<b>EUROPE</b>	Information technology equipment - Safety - Part 1: General requirements EN 60950-1: 2006
<b>U.S.A. / CANADA</b>	to meet UL60950-1:2007 / CSA C22.2- No. 60950-1-7:2007

<b>EMC</b>	<b>Harmonized Standards</b>
<b>EU</b>	Generic emission standard for industrial environments (Emission): EN 61000-6-4:2007  Generic standards - Immunity for industrial environments (Immunity): EN 61000-6-2:2005
<b>U.S.A.</b>	FCC 47 CFR Part 15, Class A
<b>CANADA</b>	ICES-003, Class A

## 13. Standard Interfaces – Pin Assignments

Low-active signals are indicated by a minus sign.

### 13.1. Serial Interface (RS232)

Pin	Signal Name	9-pin D-SUB Connector (male)
1	DCD (Data Carrier Detect)	
2	RXD (Receive Data)	
3	TXD (Transmit Data)	
4	DTR (Data Terminal Ready)	
5	GND (Signal Ground)	
6	DSR (Data Set Ready)	
7	RTS (Request to Send)	
8	CTS (Clear to Send)	
9	RI (Ring Indicator)	

### 13.2. VGA Port

Pin	Signal Name	15-pin D-SUB Connector (female)
1	Analog red output	
2	Analog green output	
3	Analog blue output	
4	N.C.	
5-8	GND	
9	+5 V (DDC)	
10	GND	
11	N.C.	
12	SDA (DDC)	
13	TTL HSync	
14	TTL VSync	
15	SCL (DDC)	

### 13.3. USB Port

Pin	Signal Name	4-pin USB Connector Type A Version 2.0
1	VCC	
2	Data-	
3	Data+	
4	GND	

### 13.4. PS/2 Keyboard Connector

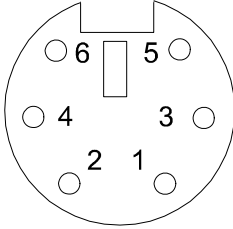
Pin	Signal Name	6-pin Mini-DIN Connector
1	Keyboard Data	
2	N.C.	
3	GND	
4	+5 V	
5	Keyboard Clock	
6	V.C.	

### 13.5. PS/2 Mouse Connector

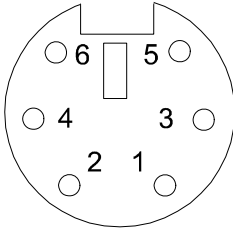
Pin	Signal Name	6-pin Mini-DIN Connector
1	Mouse Data	
2	N.C.	
3	GND	
4	+5 V	
5	Mouse Clock	
6	N.C.	



## 14. Technical Support

For technical support, please contact our Technical Support department:

Tel: +49 (0) 8165/77 112  
 e-mail: [support-keu@kontron.com](mailto:support-keu@kontron.com)  
 Web: <http://www.kontron.com/support>

Make sure you have the following information on hand when you call:

- the unit part id number (PN),
- the serial number (SN) of the unit; the serial number can be found on the type label, placed on the right side of the system.

Be ready to explain the nature of your problem to the service technician.

If you have questions about Kontron Europe or our products and services, you can reach us by the above-mentioned telephone number and on e-mail address or at: [www.kontron.com](http://www.kontron.com).

### 14.1. Returning Defective Merchandise

Please follow these steps before you return any merchandise to Kontron Europe:

1. Download the corresponding form for returning a device with an RMA No. [RMA (Return of Material Authorization)] from our website [www.kontron.com](http://www.kontron.com) / Support / .RMA Information; contact our Customer Service department to obtain an RMA No.  
 e-Mail: [service@kontron.com](mailto:service@kontron.com)
2. Ensure that you have received an RMA number from Kontron Customer Services before returning any device. Write this number clearly on the outside of the package.
3. Describe the fault that has occurred.
4. Please provide the name and telephone number of a person we can contact to obtain more information, where necessary. Where possible, please enclose all the necessary customs documents and invoices.
5. When returning a device:
  - Pack it securely in its original box.
  - Enclose a copy of the RMA form with the consignment.

### Corporate Offices

Europe, Middle East & Africa	North America	Asia Pacific
Oskar-von-Miller-Str. 1 85386 Eching/Munich Germany Tel.: +49 (0)8165/ 77 777 Fax: +49 (0)8165/ 77 219 <a href="mailto:info@kontron.com">info@kontron.com</a>	14118 Stowe Drive Poway, CA 92064-7147 USA Tel.: +1 888 294 4558 Fax: +1 858 677 0898 <a href="mailto:info@us.kontron.com">info@us.kontron.com</a>	17 Building,Block #1,ABP. 188 Southern West 4th Ring Beijing 100070, P.R.China Tel.: + 86 10 63751188 Fax: + 86 10 83682438 <a href="mailto:info@kontron.cn">info@kontron.cn</a>

